

SA

TRAILER

& CHASSIS EQUIPMENT

AUTOMOTIVE CABLE

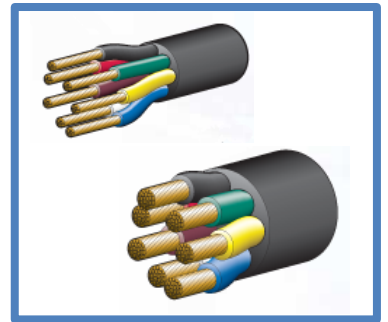
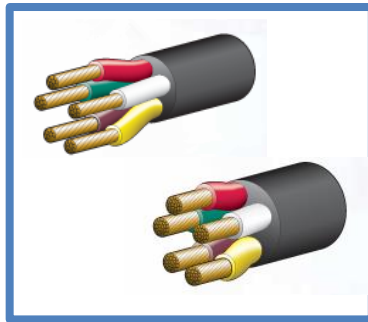
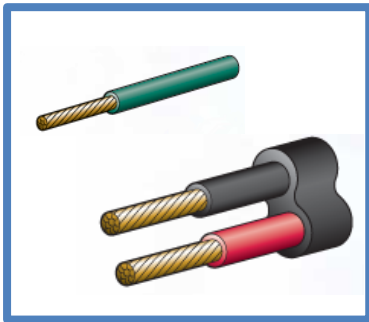

136 Port Wakefield Road, CAVAN SA 5094

Ph. 08 8262 7170 Fax. 08 8262 6123

www.satrailer.com.au

SINGLE CORE

PART NO.	DESCRIPTION
ASC11603B100	ROLL OF 500mtrs x 3mm SINGLE CORE WIRE BLACK
ASC11603G100	ROLL OF 500mtrs x 3mm SINGLE CORE WIRE GREEN
ASC11603L100	ROLL OF 500mtrs x 3mm SINGLE CORE WIRE BLUE
ASC11603N100	ROLL OF 500mtrs x 3mm SINGLE CORE WIRE BROWN
ASC11603R100	ROLL OF 500mtrs x 3mm SINGLE CORE WIRE RED
ASC11603W100	ROLL OF 500mtrs x 3mm SINGLE CORE WIRE WHITE
ASC11603Y100	ROLL OF 500mtrs x 3mm SINGLE CORE WIRE YELLOW



TWIN SHEATH

PART NO.	DESCRIPTION
AWC21603	1mtr OF 3mm TWIN SHEATH WIRE
AWC21603B30	ROLL OF 30mtrs x 3mm TWIN SHEATH WIRE
AWC21603B100	ROLL OF 100mtrs x 3mm TWIN SHEATH WIRE
AWC21603B500	ROLL OF 500mtrs x 3mm TWIN SHEATH WIRE
AWC22603	1mtr OF 4mm TWIN SHEATH WIRE
AWC22603B30	ROLL OF 30mtrs x 4mm TWIN SHEATH WIRE
AWC22603B100	ROLL OF 100mtrs x 4mm TWIN SHEATH WIRE
AWC22603B500	ROLL OF 500mtrs x 4mm TWIN SHEATH WIRE
AWC24103B30	ROLL OF 30mtrs x 5mm TWIN SHEATH WIRE
AWC24103B100	ROLL OF 100mtrs x 5mm TWIN SHEATH WIRE
AWC26503B30	ROLL OF 30mtrs x 6mm TWIN SHEATH WIRE
AWC26503B100	ROLL OF 100mtrs x 6mm TWIN SHEATH WIRE

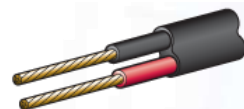

3mm



4mm

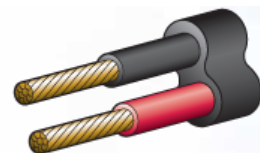

5mm

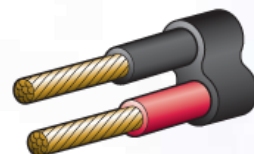

6mm

5 CORE

PART NO.	DESCRIPTION	CORE DIA.
ATC57032	1mtr OF 5 CORE WIRE [STD]	2.2 mm
ATC57032B30	ROLL OF 30mtrs 5 CORE WIRE [STD]	2.2 mm
ATC57032B100	ROLL OF 100mtrs 5 CORE WIRE [STD]	2.2 mm
ATC57032B500	ROLL OF 500mtrs 5 CORE WIRE [STD]	2.2 mm
ATC51603	1mtr OF 5 CORE WIRE [M/DUTY]	3 mm
ATC51603B30	ROLL OF 30mtrs 5 CORE WIRE [M/DUTY]	3 mm
ATC51603B100	ROLL OF 100mtrs 5 CORE WIRE [M/DUTY]	3 mm
ATC52603	1mtr OF 5 CORE WIRE [H/DUTY]	4 mm
ATC52603B30	ROLL OF 30mtrs 5 CORE WIRE [H/DUTY]	4 mm
ATC52603B100	ROLL OF 100mtrs 5 CORE WIRE [H/DUTY]	4 mm

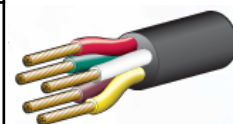

5 CORE
STD DUTY

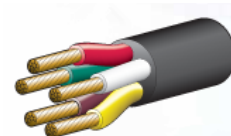

5 CORE
MED DUTY

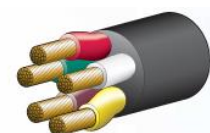

5 CORE
HEAVY DUTY

7 CORE

PART NO.	DESCRIPTION	CORE DIA.
ATC77032	1mtr OF 7 CORE WIRE [STD]	2.2 mm
ATC77032B30	ROLL OF 30mtrs 7 CORE WIRE [STD]	2.2 mm
ATC77032B100	ROLL OF 100mtrs 7 CORE WIRE [STD]	2.2 mm
ATC71603	1mtr OF 7 CORE WIRE [M/DUTY]	3 mm
ATC71603B30	ROLL OF 30mtrs 7 CORE WIRE [M/DUTY]	3 mm
ATC71603B100	ROLL OF 100mtrs 7 CORE WIRE [M/DUTY]	3 mm
ATC72603	1mtr OF 7 CORE WIRE [H/DUTY]	4 mm
ATC72603B30	ROLL OF 30mtrs 7 CORE WIRE [H/DUTY]	4 mm
ATC72603B100	ROLL OF 100mtrs 7 CORE WIRE [H/DUTY]	4 mm

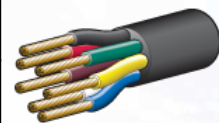

7 CORE
STD DUTY

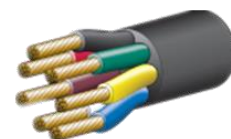

7 CORE
MED DUTY

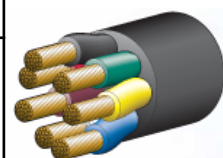

7 CORE
HEAVY DUTY

SA

TRAILER

& CHASSIS EQUIPMENT

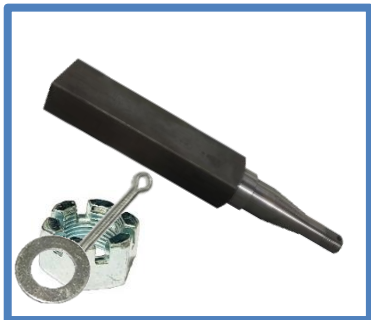

AXLES & STUBS

- **STUB C/W N.W.P**
- **STUB C/W HUB**
- **AXLE C/W N.W.P**
- **AXLE C/W HUB**



136 Port Wakefield Road, CAVAN SA 5094

Ph. 08 8262 7170 Fax. 08 8262 6123

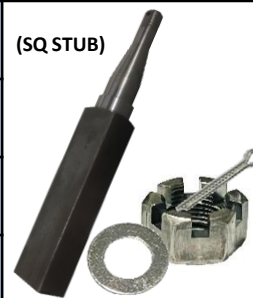

www.satrailer.com.au

**STUBS TO SUIT STD ('A' TYPE) (LM) BEARING
(1000KG PER PAIR CARRYING CAPACITY)**

PART NO.	DESCRIPTION	LENGTH	(RND STUB)
39R8A	39MM RND STUB c/w 3/4" NUT, WASHER & PIN Suit Bearing Combination LM11949 & LM67048 Grade of Steel: 1045	UP TO 8"	
39R9A		UP TO 9"	
39R10A		UP TO 10"	
39R12A		UP TO 12"	
40S8A	40MM SQ STUB c/w 3/4" NUT, WASHER & PIN Suit Bearing Combination LM11949 & LM67048 Grade of Steel: 1045	UP TO 8"	
40S9A		UP TO 9"	
40S10A		UP TO 10"	
40S12A		UP TO 12"	

PLEASE NOTE : FOR ALL ABOVE PART NO. WE ONLY USE AUSTRALIAN STEEL

**STUBS TO SUIT H/D ('B' TYPE) (SLIMLINE) BEARING
(1250KG PER PAIR CARRYING CAPACITY)**

PART NO.	DESCRIPTION	LENGTH	
50R8B	50MM RND STUB c/w 7/8" NUT, WASHER & PIN Suit Bearing Combination LM12749 & L68149 Grade of Steel: 1045	UP TO 8"	(RND STUB) 
50R9B		UP TO 9"	
50R10B		UP TO 10"	
50R12B		UP TO 12"	
45S8B	45MM SQ STUB c/w 7/8" NUT, WASHER & PIN Suit Bearing Combination LM12749 & L68149 Grade of Steel: 1045	UP TO 8"	
45S9B		UP TO 9"	
45S10B		UP TO 10"	
45S12B		UP TO 12"	
50S8B	50MM SQ STUB c/w 7/8" NUT, WASHER & PIN Suit Bearing Combination LM12749 & L68149 Grade of Steel: 1045	UP TO 8"	(SQ STUB) 
50S9B		UP TO 9"	
50S10B		UP TO 10"	
50S12B		UP TO 12"	

PLEASE NOTE : FOR ALL ABOVE PART NO. WE ONLY USE AUSTRALIAN STEEL



PART NO.	DESCRIPTION	CARRYING CAPACITY	
45P12	45MM SQ X 12" PARALLEL STUB C/W 1" NUT, WASHER & PIN Suit Bearing Combination L68149/10 & L68149/10 Grade of Steel: 1045	800KG	
50P12	50MM SQ X 12" PARALLEL STUB C/W 1" NUT, WASHER & PIN Suit Bearing Combination L68149/10 & L68149/10 Grade of Steel: 1045	800KG	
56D12	56MM RND x 12" "D" TYPE STUB C/W 1" NUT, WASHER & PIN Suit Bearing Combination LM29749/10 & LM67048/10 Grade of Steel: 1045	850KG	
50D12	50MM SQ x 12" "D" TYPE STUB C/W 1" NUT, WASHER & PIN Suit Bearing Combination LM29749/10 & LM67048/10 Grade of Steel: 1045	850KG	
50E12	50MM SQ X 16" 2 TON LIGHT DUTY STUB C/W 1" NUT, WASHER & PIN Suit Bearing Combination 15123/15245 & HR30210J Grade of Steel: 1045	1000KG	
63E16	63MM SQ X 16" 2.25 TON STUB C/W 1" NUT, WASHER & PIN Suit Bearing Combination 15123/15245 & HR30210J Grade of Steel: 1045	1125KG	
63F16	63MM SQ X 16" 3 TON STUB C/W 1.1/4" NUT, WASHER & PIN Suit Bearing Combination 29749/10 & HR30210J Grade of Steel: 1045	1500KG	

PLEASE NOTE : FOR ALL ABOVE PART NO. WE ONLY USE AUSTRALIAN STEEL

STUBS TO SUIT PARALLEL BEARINGS

PART NO.	DESCRIPTION	STUD PATTERN	
45P12HF	45MM SQ x 12" PARALLEL STUB c/w HUB ASS. Suit Bearing Combination L68149 & L68149 Grade of Steel: 1045	FORD	
45P12HT5		TLC/5	
45P12HT6		TLC/6	
50P12HF	50MM SQ x 12" PARALLEL STUB c/w HUB ASS. Suit Bearing Combination L68149 & L68149 Grade of Steel: 1045	FORD	
50P12HT5		TLC/5	
50P12HT6		TLC/6	

STUBS TO SUIT "D" TYPE BEARINGS

PART NO.	DESCRIPTION	STUD PATTERN	
56D12HT5	56MM RND x 12" "D" TYPE STUB c/w HUB ASS. Suit Bearing Combination LM29749 & LM67048 Grade of Steel: 1045	TLC/5	
56D12HT6		TLC/6	
50D12HT5	50MM SQ x 12" "D" TYPE STUB c/w HUB ASS. Suit Bearing Combination LM29749 & LM67048 Grade of Steel: 1045	TLC/5	
50D12HT6		TLC/6	

STUBS TO SUIT 2 TON BEARINGS

PART NO.	DESCRIPTION	STUD PATTERN	
50E12HT5	50MM SQ x 16" 2 TON L/D STUB c/w HUB ASS. Suit Bearing Combination 15123/45 & HR30210 Grade of Steel: 1045	TLC/5	
50E12HT6		TLC/6	

PLEASE NOTE : FOR ALL ABOVE PART NO. WE ONLY USE AUSTRALIAN STEEL

FITTED WITH HUB

STUBS TO SUIT 2.25 TON BEARINGS



PART NO.	DESCRIPTION	STUD PATTERN	
63E16HT5	63MM SQ x 16" 2.25 TON STUB c/w HUB ASS. (2.25 TON PER PAIR)	TLC/5	
63E16HT6	Suit Bearing Combination 15123/45 & HR30210 Grade of Steel: 1045	TLC/6	

STUBS TO SUIT 3 TON BEARINGS

PART NO.	DESCRIPTION	STUD PATTERN	
63F16HT5	63MM SQ x 16" 3 TON STUB c/w HUB (3 TON PER PAIR)	TLC/5	
63F16HT6	Suit Bearing Combination LM29749 & HR30210 Grade of Steel: 1045	TLC/6	

PLEASE NOTE : FOR ALL ABOVE PART NO. WE ONLY USE AUSTRALIAN STEEL

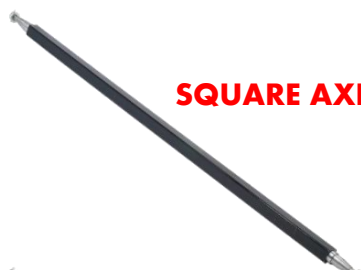

AXLE TO SUIT STD ('A' TYPE) (LM) BEARINGS

PART NO.	DESCRIPTION	LENGTH	
39RAOA72	39MM RND [A] AXLE ONLY c/w NUTS, WASHER & PIN Suit Bearing Combination LM11949 & LM67048 Grade of Steel: 1045	UP TO 72"	 <p>SQUARE AXLE</p>  <p>ROUND AXLE</p>
39RAOA84		UP TO 84"	
39RAOA96		UP TO 96"	
40SAOA72	40MM SQ [A] AXLE ONLY c/w NUTS, WASHER & PIN Suit Bearing Combination LM11949 & LM67048 Grade of Steel: 1045	UP TO 72"	
40SAOA84		UP TO 84"	
40SAOA96		UP TO 96"	

PLEASE NOTE: THE PHOTOS SHOWN ARE FOR ILLUSTRATION PURPOSE ONLY

PLEASE NOTE : FOR ALL ABOVE PART NO. WE ONLY USE AUSTRALIAN STEEL

AXLE TO SUIT HD ('B' TYPE) (SLIMLINE) BEARINGS

PART NO.	DESCRIPTION	LENGTH	
50RAOB72	50MM RND [B] AXLE ONLY c/w NUTS, WASHER & PIN Suit Bearing Combination LM12749 & L68149 Grade of Steel: 1045	UP TO 72"	 <p>ROUND AXLE</p>  <p>SQUARE AXLE</p>
50RAOB84		UP TO 84"	
50RAOB96		UP TO 96"	
45SAOB72	45MM SQ [B] AXLE ONLY c/w NUTS, WASHER & PIN Suit Bearing Combination LM12749 & L68149 Grade of Steel: 1045	UP TO 72"	
45SAOB84		UP TO 84"	
45SAOB96		UP TO 96"	
50SAOB72	50MM SQ [B] AXLE ONLY c/w NUTS, WASHER & PIN Suit Bearing Combination LM12749 & L68149 Grade of Steel: 1045	UP TO 72"	
50SAOB84		UP TO 84"	
50SAOB96		UP TO 96"	



PLEASE NOTE: THE PHOTOS SHOWN ARE FOR ILLUSTRATION PURPOSE ONLY

PLEASE NOTE : FOR ALL ABOVE PART NO. WE ONLY USE AUSTRALIAN STEEL

AXLE TO SUIT PARALLEL BEARINGS

PART NO.	DESCRIPTION	LENGTH	
45PA072	45MM SQ x 72" PARALLEL AXLE ONLY c/w NUTS, WASHER & PIN Suit Bearing Combination L68149 & L68149 Grade of Steel: 1045	UP TO 72"	 <p>SQUARE AXLE</p>
45PA084		UP TO 84"	
45PA096		UP TO 96"	
50PA072	50MM SQ x 72" PARALLEL AXLE ONLY c/w NUTS, WASHER & PIN Suit Bearing Combination L68149 & L68149 Grade of Steel: 1045	UP TO 72"	
50PA084		UP TO 84"	
50PA096		UP TO 96"	

AXLE TO SUIT 'D' TYPE BEARINGS

PART NO.	DESCRIPTION	LENGTH	
56DA072	56MM RND "D" TYPE AXLE ONLY c/w NUTS, WASHER & PIN Suit Bearing Combination LM29749 & LM67048 Grade of Steel: 1045	UP TO 72"	 <p>ROUND AXLE</p>  <p>SQUARE AXLE</p>
56DA084		UP TO 84"	
56DA096		UP TO 96"	
50DA072	50MM SQ "D" TYPE AXLE ONLY c/w NUTS, WASHER & PIN Suit Bearing Combination LM29749 & LM67048 Grade of Steel: 1045	UP TO 72"	
50DA084		UP TO 84"	
50DA096		UP TO 96"	

PLEASE NOTE: THE PHOTOS SHOWN ARE FOR ILLUSTRATION PURPOSE ONLY

PLEASE NOTE : FOR ALL ABOVE PART NO. WE ONLY USE AUSTRALIAN STEEL

AXLE TO SUIT 2 & 2.25 TON BEARINGS

PART NO.	DESCRIPTION	LENGTH	 <p>SQUARE AXLE</p>
50EA072	50MM SQ 2 TON L/D AXLE ONLY c/w NUTS, WASHER & PIN Suit Bearing Combination 15123/45 & HR30210 Grade of Steel: 1045	UP TO 72"	
50EA084		UP TO 84"	
50EA096		UP TO 96"	
63EA072	63MM SQ 2.25 TON AXLE ONLY c/w NUTS, WASHER & PIN Suit Bearing Combination 15123/45 & HR30210 Grade of Steel: 1045	UP TO 72"	
63EA084		UP TO 84"	
63EA096		UP TO 96"	

AXLE TO SUIT 3 TON BEARINGS

PART NO.	DESCRIPTION	LENGTH	 <p>SQUARE AXLE</p>
63FA072	63MM SQ 3 TON AXLE ONLY c/w NUTS, WASHER & PIN Suit Bearing Combination LM29749 & HR30210 Grade of Steel: 1045	UP TO 72"	
63FA084		UP TO 84"	
63FA096		UP TO 96"	

PLEASE NOTE: THE PHOTOS SHOWN ARE FOR ILLUSTRATION PURPOSE ONLY

PLEASE NOTE : FOR ALL ABOVE PART NO. WE ONLY USE AUSTRALIAN STEEL

ANTI THEFT PRODUCTS



136 Port Wakefield Road, CAVAN SA 5094

Ph. 08 8262 7170 Fax. 08 8262 6123

www.satrailer.com.au



P/N: 450-06072

PURPLELINE ANTI THEFT PACK

(Fits tyre widths of 145 to 275 mm
Suitable for both on and off road wheels
Fits standard 50mm Australian ball hitches
Quick and easy to fit)



P/N: 450-06064

NEMESIS WHEEL CLAMP

(Fit around and lock onto the wheels to
prevent trailer and vehicle from being towed away.
Suitable for steel and alloy wheels from 10" – 20"
Wheels, and 14.5 cm – 27.5 cm tyres in width
Weight: 14 kg)



P/N: 450-00910

TRAILER COP ANTI-THEFT COUPLING LOCK

(Suitable for use on 50 mm couplers)



P/N: 450-00924

KOVIX ALARMED TRAILER LOCK

(Weatherproof Electronics (IP67) & rust resistant
Removable Ball to Fit a Wide Range of Hitches
(H 100 mm x W 155 mm x D 35 mm –
Inside W 80 mm))



P/N: MHARHP

MH ANTI-RATTLE LOCKING HITCH PIN (5/8")

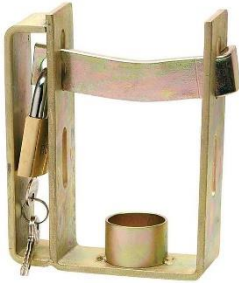

P/N: CPL10
DUAL COUPLING LOCK



P/N: CM061
HITCH PIN LOCK – 5/8” x 65mm



P/N: CM062
HITCH PIN LOCK - 5/8” x 85mm

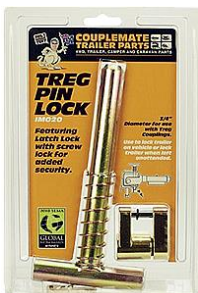

P/N: CM056
**TREG SPRING LOADED PIN c/w
LOCK**



TEKONSHA P3 HAND CONTROLLER

BRAKE CONTROLLER



ELECBRAKES IN-CAR REMOTE CONTROL



ELECBRAKES ELECTRIC BRAKE CONTROLLER

REDARC TOW-PRO ELITE ELECTRIC
BRAKE CONTROLLER

ACTIVE FAB BRAKE CONTROLLER











TEKONSHA PRIMUS IQ HAND CONTROLLER

136 Port Wakefield Road, CAVAN SA 5094

Ph. 08 8262 7170 Fax. 08 8262 6123

www.satrailer.com.au

PART NO.	DESCRIPTION	
90195	TEKONSHA P3 Hand controller Suit: 1 - 4 Axles with Brakes Dimension: 3" L x 4.5" W x 10.63" H Weight: 0.68 kg	
90160	TEKONSHA PRIMUS IQ Hand controller Suit: 1 - 3 Axles with Brakes Dimension: 2.5" L x 4.5" W x 8.5" H Weight: 0.57 kg	
7686	PRODIGY Pocket Mount Kit	
333064	PRIMUS Pocket Mount Kit	
7894	PRODIGY Wiring Loom	
2801	Active Fab Brake Controller Suit: 1 - 2 Axles with Brakes Dimension: 95mm L x 58mm W x 30mm H Weight: 0.174 kg	
EBRH-ACC3	REDARC Tow-Pro Elite Electric Brake Controller	

PART NO.	DESCRIPTION	
ELBC2000-PS	Elecbrakes Electric Brake Controller	
ELBEBRC	Elecbrakes In-car Remote Control	
A7-7	Flat 7 Pin Adapter To Flat 7 Pin Socket Suit Elecbrakes	
A7LR-7	Large Round 7 Pin Adapter To Flat 7 Pin Socket Suit Elecbrakes	
A7LR-A7LR	Large Round 7 Pin Adapter To Large Round 7 Pin Socket Suit Elecbrakes	
A7-12	Flat 7 Pin Adapter To Flat 12 Pin Socket Suit Elecbrakes	
A12-12	Flat 12 Pin Adapter To Flat 12 Pin Socket Suit Elecbrakes	
TWL	1.5mtrs Trailer Wired Leader Suit Elecbrakes	

BREAK-AWAY UNIT

- BREAKSAFE UNIT
- StaySAFE UNIT



136 Port Wakefield Road, CAVAN SA 5094

Ph. 08 8262 7170 Fax. 08 8262 6123

www.satrailer.com.au

BREAK-AWAY UNITS

BREKSAFE



4024

SA6000 BREAKSAFE UNIT

- TO SUIT 2 & 4 WHEEL BRAKE
- INCLUDING:
 - 1 OFF NP7 12V BATTERY
 - 1 OFF BREAKAWAY SWITCH c/w COIL CABLE
 - SET OF MOUNTING HARDWARE
 - INSTALLATION INSTRUCTION BOOK







4068

SA6000XP BREAKSAFE UNIT

- TO SUIT 6 WHEEL BRAKE
- INCLUDING:
 - 1 OFF NP9 12V BATTERY
 - 1 OFF BREAKAWAY SWITCH c/w COIL CABLE
 - SET OF MOUNTING HARDWARE
 - INSTALLATION INSTRUCTION BOOK

BREAK-AWAY UNITS

BREAKSAFE

	PART NUMBER	DESCRIPTION
	SA5000RM	5000 REMOTE MONITORS
	BAT	REPLACEMENT BREAKSAFE BATTERY 7 A/H - TO SUIT SA6000
	BATXP	REPLACEMENT BREAKSAFE BATTERY 9 A/H - TO SUIT SA6000XP
	SA0172W	REPLACEMENT COIL CABLE & PIN
	SA0172	REPLACEMENT BREAKAWAY SWITCH c/w COIL CABLE

ELECTRIC BREAK-AWAY SYSTEM



SA7000 StaySAFE UNIT

- TO SUIT 2000 – 4499KG ON 2, 4 & 6 WHEEL BRAKE
- PASSED TEST IN AUSTRALIA TO ADR38/04 SPECIFICATIONS
- COMPLIES WITH ADR38/04 AUSTRALIA WIDE (REMOTE MONITOR FOR NSW)
- INCLUDING:
 - A - StaySAFE CONTROL UNIT WITH HEAVY DUTY 12V BATTERY (1 OFF)
 - B - StaySAFE REMOTE BATTERY LEVEL MONITOR (1 OFF)
 - C - StaySAFE 240V to 12V BATTERY CHARGER (1 OFF)
 - D - StaySAFE BREAKAWAY SWITCH c/w LANYARD & CLIP (1 OFF)
 - COMPREHENSIVE INSTRUCTION BOOK (1 OFF)
- SPARE PARTS AVAILALE





CARAVAN ACCESSORIES

- AK ANTI THEFT WHEEL CLAMP
- PLASTIC BATTERY BOX
- CAMCO TRAILER AID PLUS
- EASY CARAVAN JACK
- CORNER STEADIES & PARTS
- WATER TANKS & PARTS

136 Port Wakefield Road, CAVAN SA 5094

Ph. 08 8262 7170 Fax. 08 8262 6123

www.satrailer.com.au



P/N 650300

AK ANTI THEFT WHEEL CLAMP

- Heavy duty weather resistant steel
- Anti-Scratch coating to protect your wheels
- Adjustable to suit 13-15" wheels
- Portable and easy to use
- Key operated lock



P/N BB27

PLASTIC BATTERY BOX c/w LID & STRAP [small]

INTERNAL DIMENSION		
LENGTH (mm)	WIDTH (mm)	HEIGHT (mm)
275	180	200



P/N BB32

PLASTIC BATTERY BOX c/w LID & STRAP [large]

INTERNAL DIMENSION		
LENGTH (mm)	WIDTH (mm)	HEIGHT (mm)
325	185	200

PART NO.	DESCRIPTION	
450-00232	CAMCO TRAILER AID PLUS	
CM070	EASY CARAVAN JACK to suit 14" - 16" WHEELS 1000KG	



654859

590mm DROP LEG JACK & BIG FOOT

SURFACE FINISH	CLOSED LENGTH	OPEN LENGTH
ZINC PLATED	410MM	590MM



654874

740mm DROP LEG JACK & BIG FOOT

SURFACE FINISH	CLOSED LENGTH	OPEN LENGTH
ZINC PLATED	510MM	740MM



654884

840mm DROP LEG JACK & BIG FOOT

SURFACE FINISH	CLOSED LENGTH	OPEN LENGTH
ZINC PLATED	610MM	840MM



654859B

590mm DROP LEG JACK & BIG FOOT BLACK

SURFACE FINISH	CLOSED LENGTH	OPEN LENGTH
BLACK	410MM	590MM



654874B

740mm DROP LEG JACK & BIG FOOT BLACK

SURFACE FINISH	CLOSED LENGTH	OPEN LENGTH
BLACK	510MM	740MM



654884B

840mm DROP LEG JACK & BIG FOOT BLACK

SURFACE FINISH	CLOSED LENGTH	OPEN LENGTH
BLACK	610MM	840MM



654851

**515mm DROP LEG JACK &
 BIG FOOT**

SURFACE FINISH	CLOSED LENGTH	OPEN LENGTH
ZINC PLATED	365MM	515MM

CORNER STEADIES PARTS



654881

**CORNER STEADY DROP-DOWN
 BUTTON (ONLY)**

654880

**DROP LEG JACK HANDLE
 (ONLY)**



655901

**BIG FOOT SUPPORT
 (SINGLE)**



655900

**SET OF 4 BIG FOOT
 SUPPORTS**



344400-04

**CORNER JACK HANDLE (AK)
 LONG 1150mm**



344400-03

**CORNER JACK HANDLE (AK)
 MEDIUM 800mm**



344400-02

**CORNER JACK HANDLE (AK)
 SHORT 450mm**

POLYETHYLENE WATER TANK c/w FITTINGS – 13GAL / 59LTR



PART NUMBER	REQUIRE HOSE FITTING	CAPACITY (Litre)	LENGTH (mm)	WIDTH (mm)	HEIGHT (mm)
033422	<ul style="list-style-type: none"> •033427 x 1 •042641 x 2 •006083 x 1 	59	865	490	190

POLYETHYLENE WATER TANK c/w FITTINGS – 18GAL / 82LTR



PART NUMBER	REQUIRE HOSE FITTING	CAPACITY (Litre)	LENGTH (mm)	WIDTH (mm)	HEIGHT (mm)
033423	<ul style="list-style-type: none"> •033427 x 1 •042641 x 2 •006083 x 1 	82	1220	490	190

12GAL/55 LTR ROTO CAMPER TANK C/W HOSE FITTINGS



PART NUMBER	REQUIRE HOSE FITTING	CAPACITY (Litre)	LENGTH (mm)	WIDTH (mm)	HEIGHT (mm)
006096	<ul style="list-style-type: none"> •006079 x 2 •042647 x 1 	55	760	355	230

ROTO WATER TANK c/w FITTINGS 15GAL / 70LTR



PART NUMBER	REQUIRE HOSE FITTING	CAPACITY (Litre)	LENGTH (mm)	WIDTH (mm)	HEIGHT (mm)
006099	<ul style="list-style-type: none"> •006079 x 1 •042647 x 1 	70	850	520	160

PART NO.	DESCRIPTION	
033427	BARB PLUG to suit 59 LTR AND 82 LTR WATER TANK	
006079	BARB PLUG to suit 55 LTR & 70 LTR WATER TANK	
042641	HOSE PLUG TO SUIT 59LTR & 82LTR WATER TANK	
042647	HOSE PLUG TO SUIT 55LTR & 70LTR WATER TANK	
006083	BREATHER 10mm to suit 59 LTR & 82 LTR WATER TANK	
3531-002	BREHA HAND WATER PUMP (BLACK)	
3575-020	WATER FILLER LOCKABLE (BLACK)	

COUPLING & PARTS



- AL-KO COUPLING & PARTS
- BARTLETT-COUPLING-PARTS
- CRUISEMASTER-COUPLING
- COUPLING-ACCESSORIES
- MISCELLANEOUS-COUPLING
- MACHINE-BALL
- PINTLE-HOOK



136 Port Wakefield Road, CAVAN SA 5094

Ph. 08 8262 7170 Fax. 08 8262 6123

www.satrailer.com.au

• **FIXED COUPLING**

This style of coupling, usually suited to a 50mm Australian Standard towball, is suitable to be used where either there are no brakes fitted to the trailer or the braking system does not require activation from a sliding or overrun coupling.

AL-KO couplings are simple to attach to the towball and provide safe secure attachment of the trailer to the tow vehicle.

Typical applications for domestic trailers are up to 750 kg ATM (total loaded mass), where no brakes are required. For independent brake systems such as electric or power operated like the IQ7 system for marine trailers over 2000 kg ATM (total loaded mass), a fixed coupling is the appropriate selection. Fixed couplings for 50mm towballs are suitable for up to 3500 kg ATM (total loaded trailer mass) as long as the appropriate braking system is fitted to the trailer.



PART NUMBER	616200	614060	614075	614755	614010
DESCRIPTION	PRESS STEEL COUPLING	2 HOLE COUPLING	3 HOLE COUPLING	LEVER COUPLING	ELECTRIC COUPLING & LEVER
WEIGHT RATING	750kg	2000kg	2000kg	2000kg	3500kg
SUITS TOWBALL SIZE	50mm	50mm	50mm	50mm	50mm
MOUNTING HOLE (LXW) & DIAMETER	90mm x 12.2mm	101.6mm x 13.5mm	111.1mm x 51mm x 13.5mm	90mm x 36mm x 11mm	182.5mm x 55mm x 13.5mm
SURFACE FINISH	ZINC PLATED	PAINTED	ZINC PLATED	DACROMET	ZINC PLATED
BALL TO FIRST CENTRE HOLE (NOMINAL)	110mm	77mm	67mm	95mm	128mm

Helpful Hint: Use high tensile mounting bolts on all fixed couplings!

• **OVER-RIDE COUPLING**

On trailers between 750 kg and 2000 kg total laden mass, braking systems that use an override principal are acceptable, as long as they provide adequate braking for the trailer and tow vehicle combination.

The principal of this type of coupling is a sliding shaft attached to the tow ball housing of the coupling, and as the tow vehicle slows down the force of deceleration is passed through the coupling shaft and pushed either on a mechanical linkage (for mechanical brakes) or acts on a linkage connected to a hydraulic cylinder providing hydraulic pressure to a braking system (hydraulic brakes).

This type of coupling is efficient if the ball load is not excessive and when load levelling devices are not used, as these devices impede the smooth operation of the coupling, impeding the brake performance.



PART NUMBER	614040	614042	614050	614054
DESCRIPTION	HYDRAULIC OVER-RIDE COUPLING & 19mm MASTER CYLINDER	HYDRAULIC OVER-RIDE COUPLING & 22mm MASTER CYLINDER	MECHANICAL OVER-RIDE COUPLING & LEVER	MECHANICAL OVER-RIDE COUPLING ONLY
WEIGHT RATING	2000kg	2000kg	2000kg	2000kg
SUITS TOWBALL SIZE	50mm	50mm	50mm	50mm
MOUNTING HOLE (LXW) & DIAMETER	184mm x 54mm x 13.5mm	184mm x 54mm x 13.5mm	184mm x 54mm x 13.5mm	184mm x 54mm x 13.5mm
SURFACE FINISH	ZINC PLATED	ZINC PLATED	ZINC PLATED	ZINC PLATED
BALL TO FIRST CENTRE HOLE (NOMINAL)	137mm	137mm	137mm	137mm

• **FIXED RING COUPLING**

When used in a commercial or defence department application, often a 75 mm ring type towing eye is requested.

This style of coupling is similar in function to ball type couplings (fixed and over ride) but instead of the connection to the tow vehicle being a standard 50 mm ball, the connection is a 75 mm inside diameter ring and this attaches to a "pintle hook" fitted to the tow vehicle. These types of couplings are primarily used in applications where the tow vehicle is a heavy commercial truck. As the Australian Standard AS4177 states the 50mm towball to have a maximum capacity of 3500 kg ATM (total loaded mass), ring couplings are used when higher loads are involved.

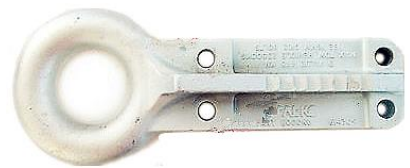



		
PART NUMBER	614304	614309
DESCRIPTION	3" RING FIXED COUPLING (3 HOLE)	3" RING FIXED COUPLING (4 HOLE)
WEIGHT RATING	3500kg	6000kg
RING SIZE	75mm	75mm
MOUNTING HOLE (LXW) & DIAMETER	103mm x 56mm x 16.8mm	182mm x 52mm x 16.8mm
SURFACE FINISH	ZINC PLATED	ZINC PLATED
BALL TO FIRST CENTRE HOLE (NOMINAL)	86mm	116mm

• **OFF-ROAD COUPLING**

When a coupling is used for rough off-road use the Australian Standard degree of articulation (or angles of available movement) may be insufficient. AL-KO has solved this problem with the AL-KO Off Road Coupling. When off-road 4WD vehicles tow trailers in rugged outback conditions it is advisable that a coupling specifically designed to have greater angular movement is used.

The AL-KO Off Road Coupling with 360 degree articulation and positive towball latching system offer the maximum degree of articulation as well as a design that has been tested to 2 million fatigue test cycles, so you know that it will pass all tests.

AL-KO has a range of suitable "off-road" couplings in both fixed and override functions to provide the appropriate articulation for this use.

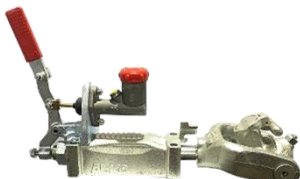
				
PART NUMBER	619350	619200	619200/53	619200/43
DESCRIPTION	ELECTRIC SWIVEL OFF-ROAD COUPLING (NON-OVER-RIDE) (NEW STYLE)	OVER-RIDE OFF-ROAD COUPLING ONLY (NEW STYLE)	MECHANICAL OVER-RIDE OFF-ROAD COUPLING & LEVER (NEW STYLE)	HYDRAULIC OVER-RIDE OFF-ROAD COUPLING & 19mm MASTER CYLINDER (NEW STYLE)
WEIGHT RATING	3500kg	2000kg	2000kg	2000kg
SUITS TOWBALL SIZE	50mm	50mm	50mm	50mm
MOUNTING HOLE (LXW)	184mm x 54mm	184mm x 54mm	184mm x 54mm	184mm x 54mm
SURFACE FINISH	ZINC PLATED	ZINC PLATED	ZINC PLATED	ZINC PLATED

• **OFF-ROAD PIN COUPLING**

Innovative market leader AL-KO has taken ease of use to a new level with the release of the AL-KO Off-Road Pin Coupling featuring their new patent pending Click Lock™ system.

With the development of Click Lock, AL-KO now offers an off-road pin coupling that is self-locking – automatically completing the primary and secondary locking required for ADR compliance, with no additional action required by the user. The result is hands free hitching, making it safer and easier to use than other pin couplings on the market. To hitch up, simply lower the coupling over the pin. An integrated positive latching indicator confirms that you are ready to go when it clicks into place.



AL-KO's unique forged yoke allows maximum articulation on both horizontal and vertical planes sustained up to 3500kg ATM. A built in cover makes the coupling completely sealed from the elements with no loose parts, levers or dust caps.

The product has the lowest profile of any pin coupling on the market at just 83mm, making it ideal for tow vehicles with barn doors.

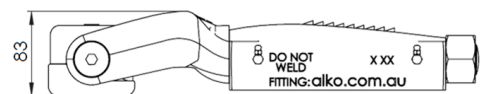
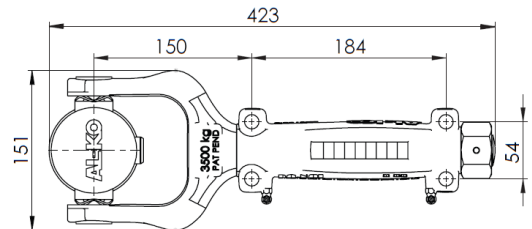
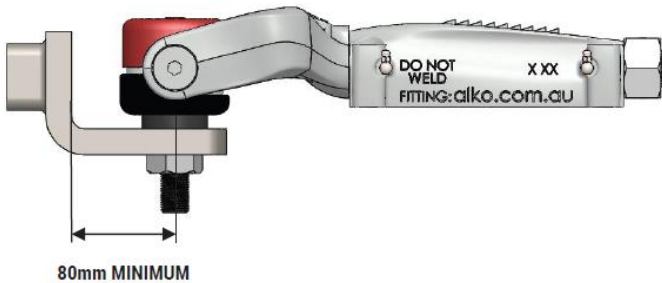
	PART NUMBER	DESCRIPTION	WEIGHT RATING	MOUNTING HOLE (LXW) & DIAMETER	SURFACE FINISH	PIN TO FIRST CENTRE HOLE (NOMINAL)
	619400	OFF-ROAD PIN COUPLING c/w PIN	3500 kg	184 x 54mm	ZINC PLATED	150 mm

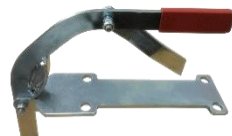

SPARE PARTS to suit ABOVE COUPLING

	PART NUMBER	DESCRIPTION
	619410	PIN to suit OFF-ROAD PIN COUPLING
	619411	COVER to suit PIN
	614055	BASE PLATE & LEVER suit AK PIN COUPLING ONLY (184 x 54 x 13.5mm)

• **SWAY CONTROL COUPLING**

AL-KO has a specific coupling designed to reduce trailer sway. This 50mm ball type fixed coupling is designed to be used on trailer up to 2500 kg ATM (total loaded mass) and with a maximum towball weight of 250 kg.

This unique product incorporates a clamping system that grips the sides of a specially designed 50 mm tow ball and resists movement of the trailer. This action slows down any tendency for the trailer to sway or veer from a straight condition.

This is particularly a benefit when large trailers such as caravans are buffeted by side winds or by a passing truck and trailer combination.

****NOTE: This type of coupling must only be used with a 50mm ball which has an anti-rotation plate for attachment to the vehicle fitted.****

	PART NUMBER	DESCRIPTION	WEIGHT RATING	SUITS TOWBALL SIZE	MOUNTING HOLE (LXW) & DIAMETER	SURFACE FINISH	BALL TO FIRST CENTRE HOLE (NOMINAL)
	618000	AKS 3000 STABILIZER COUPLING	2500kg	50mm	184mm x 54mm x 13.5mm	ZINC PLATED	203mm

SPARE PARTS to suit ABOVE COUPLING

	PART NUMBER	DESCRIPTION	SUITS TOWBALL SIZE	SIZE
	618100	RETENSION PLATE to suit AKS 2000 & 3000	50mm	75mm WIDE

FOR MORE SPARE PARTS PLEASE SEE NEXT PAGE

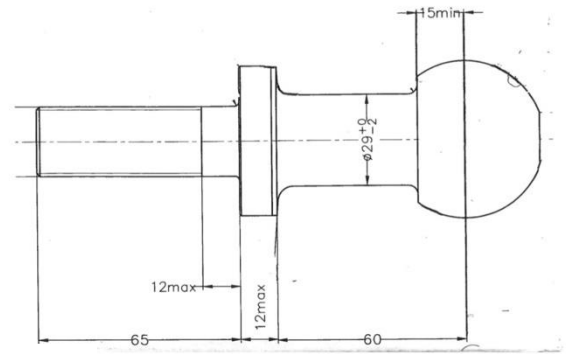
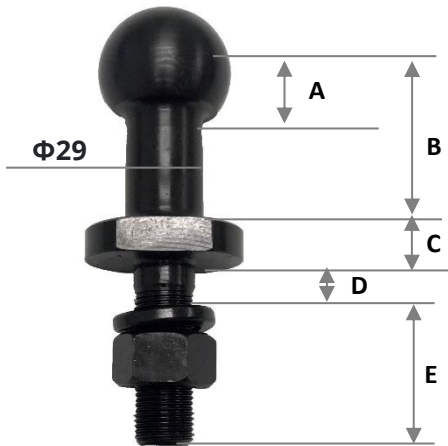

AKS 3000 HIGH RISE TOW BALL

PART NO.	SUIT TOWBALL SIZE (mm)	A (mm)	B (mm)	C (mm)	D (mm)	E (mm)
618901	50	15	60	12	12	65

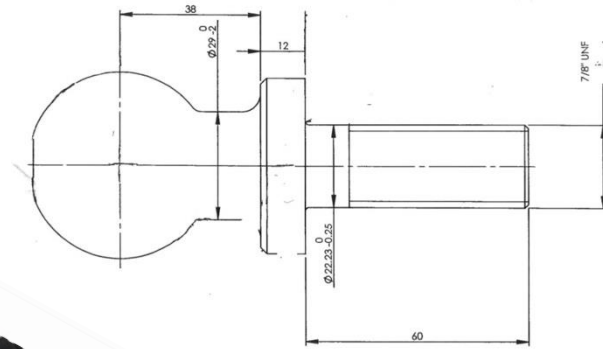
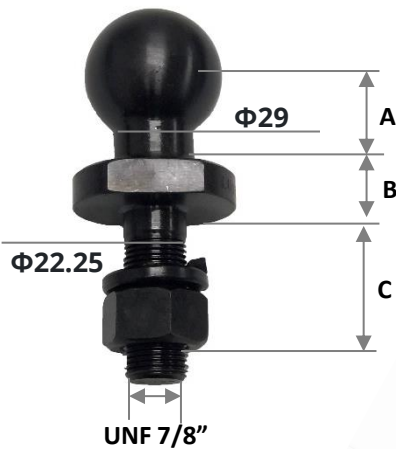

AKS 3000 STANDARD TOW BALL

PART NO.	SUIT TOWBALL SIZE (mm)	A (mm)	B (mm)	C (mm)	UNF
618904	50	38	12	60	7/8"



614065LPL

COUPLING SNAP ON 2 & 3 HOLE ZINC PLATED LOCKABLE INCLUDES LOCK & KEYS

CAPACITY	SUITS BRAKING SYSTEM	HOLE CENTRES	BOLT HOLE SIZE	RECOMMENDED BOLT SIZE	RECOMMENDED BOLT GRADE
750 KG	NON BRAKED	3 BOLT 111MM X 51MM	13.5MM	10MM	GRADE A4-80



614054LPL

COUPLING 2T OVERRIDE LOCKABLE ZINC PLATED INCLUDES LOCK & KEYS NO BRAKE PLATE

CAPACITY	SUITS BRAKING SYSTEM	HOLE CENTRES	BOLT HOLE SIZE	RECOMMENDED BOLT SIZE	RECOMMENDED BOLT GRADE
2000 KG	OVER RIDE HYDRAULIC & MECHANICAL	4 BOLT 184MM X 54MM	13.5MM	12MM	GRADE A4-80



614015L

**COUPLING ELECTRIC LOCKABLE
3.5T ZINC PLATED INCLUDES LOCK & KEYS**

CAPACITY	SUITS BRAKING SYSTEM	HOLE CENTRES	BOLT HOLE SIZE	RECOMMENDED BOLT SIZE	RECOMMENDED BOLT GRADE
3500 KG	ELECTRIC & POWER ASSISTED	4 BOLT 182.5MM X 55MM	13.5MM	12MM	GRADE A4-80



614015LPBWCA

**COUPLING ELECTRIC LOCKABLE 3.5T PREMIUM
PUSH BUTTON PARK LEVER WITH CABLE ADJUSTER**

CAPACITY	SUITS BRAKING SYSTEM	HOLE CENTRES	BOLT HOLE SIZE	RECOMMENDED BOLT SIZE	RECOMMENDED BOLT GRADE
3500 KG	ELECTRIC & POWER ASSISTED	4 BOLT 182.5MM X 55MM	13.5MM	12MM	GRADE A4-80

	PART No.	DESCRIPTION	SURFACE FINISH	MOUNTING HOLE (LXW) & DIAMETER
	P6575	19mm or 3/4" MASTER CYLINDER ONLY	--	--
	P7890	22mm or 7/8" MASTER CYLINDER ONLY	--	--
	313001	19mm ALKO MASTER CYLINDER	--	--
	610943	MASTER CYLINDER MOUNT BRACKET c/w 19mm MASTER CYLINDER	ZINC PLATED	--
	610944	MASTER CYLINDER MOUNT BRACKET c/w 22mm MASTER CYLINDER	ZINC PLATED	--
	614053	MECHANICAL BASE PLATE & LEVER	ZINC PLATED	184mm x 54mm x 13.5mm
	619100	AK ZINC PLATED HANDBRAKE LEVER	ZINC PLATED	--

	PART NO.	DESCRIPTION
	P4982	19MM MASTER CYLINDER CAP ONLY
 OR	MC78C	7/8" MASTER CYLINDER CAP ONLY WHITE/BLACK
	78BC	7/8" RESERVOIR COMPLETE & CAP
	78BOWL	7/8" PLASTIC BOWL ONLY No CAP

PART NO.	DESCRIPTION	
D035	<p>DO35 V3 COUPLING C/W H/BRAKE LEVER & BOLT KIT</p> <p>ITEM INCLUDES (DO35 V3Plus (With Handbrake), Tow Pin 7/8" Shaft, Tow Pin Cover, Universal C-Spanner, Fitment Bolts, User Guide)</p>	 <p>U3 PLUS</p>
D035KIT	<p>DO35 TOW PIN KIT (BOXED)</p> <p>ITEM INCLUDES (Standard DO35 Tow Pin, Pin Cover, C-Spanner)</p>	 <p>CRUISEMASTER DO35 U3 PLUS <small>+ OLDER DO35 MODELS</small></p> <p>STANDARD SIZE PIN</p>
D035LOCK	<p>DO35 LOCK KIT</p> <p>ITEM INCLUDES</p>	 <p>CRUISEMASTER DO35 <small>ALL GENERATIONS</small></p>
D045	<p>DO45 COUPLING C/W H/BRAKE LEVER & BOLTS KIT</p> <p>ITEM INCLUDES (DO45 Plus (With Handbrake), Tow Pin 1.1/4" Shaft, Tow Pin Cover, Universal C-Spanner, Fitment Bolts, User Guide)</p>	 <p>CRUISEMASTER DO45 PLUS</p>

PART NO.	DESCRIPTION	
DO45KIT	<p>DO45 TOW PIN KIT (BOXED)</p> <p>ITEM INCLUDES (Standard DO45Plus Tow Pin, Pin Cover, C-Spanner)</p>	
DO45LOCK	<p>DO45 LOCK KIT</p> <p>ITEM INCLUDES</p>	

• **95mm BALL TRAILER COUPLING**



375AX

95mm TRAILER COUPLING

RIGID DRAWBAR: MAX. ATM 7000KG

HINGED DRAWBAR: D-VALUE 70KN



(INCL.: A - 375/11 1" BOLT SET;

B - 375/10 3/4" BOLT SET;

C - 375/1 TRAILER HOOD)



375DX

95mm BALL & TRUCK KIT

RIGID DRAWBAR: MAX. ATM 7000KG

HINGED DRAWBAR: D-VALUE 70KN



B



C



D



E



F



G



(INCL: A - 5-3/9 SAFETY SPRING;

B - 375/6 CLAMPING BOLT;

C - 375/7 COMPRESSION SPRING;

D - 375/3 CAP;

E - 375/4 MAIN BOLT;

F - 375/2 BALL;

G - 5-3/5 NYLOC NUT & WASHER)

• **95mm BALL TRAILER COUPLING**

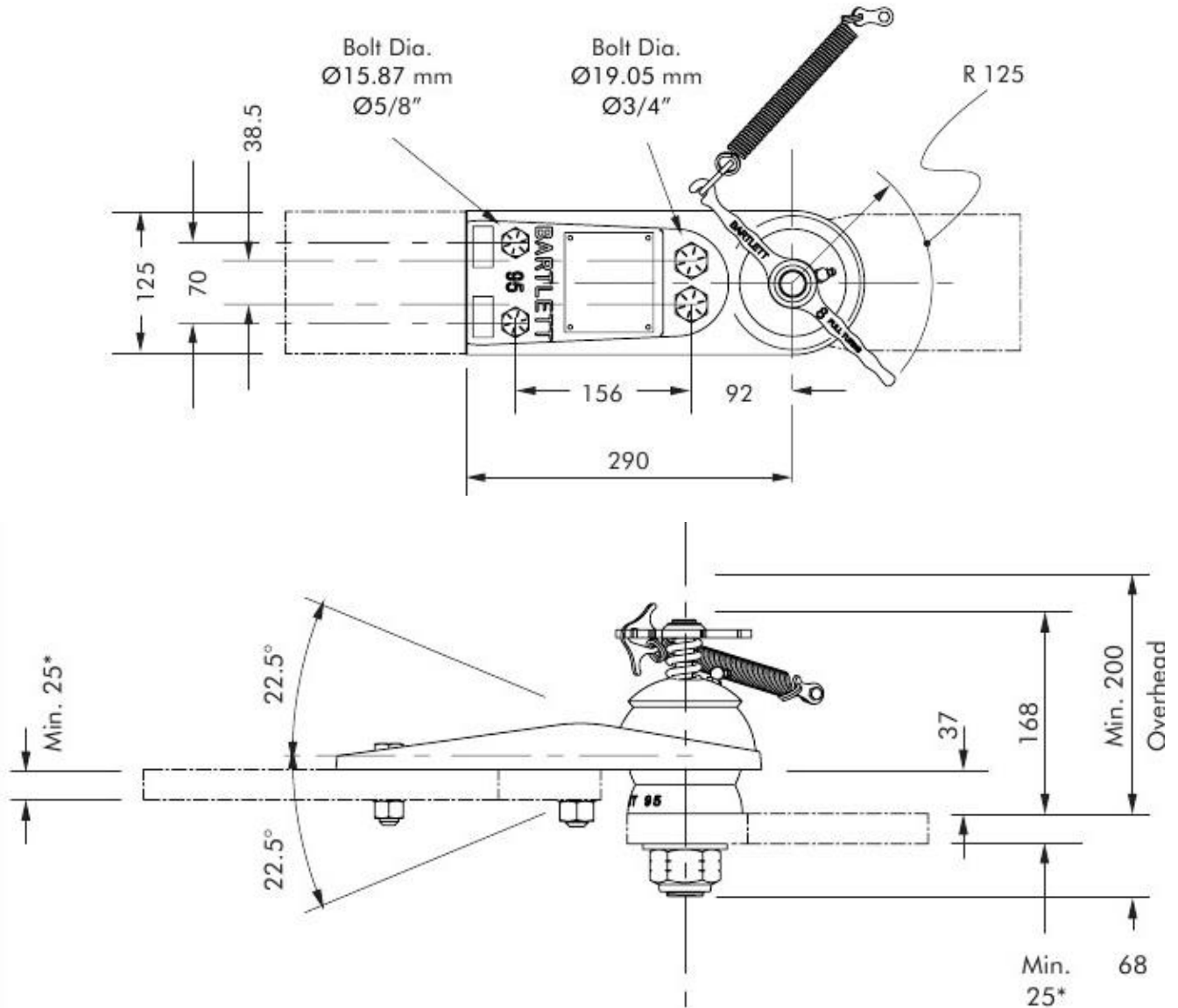

Do not scale - All measurements in mm

*Mounting lugs not included, shown for illustration purpose only - available at extra cost

*Mounting lugs must be adequately supported as dictated by professional design engineer

*DWG or DXF file available approval

• **127mm BALL TRAILER COUPLING**



59AX
127mm TRAILER COUPLING

RIGID DRAWBAR: MAX. ATM 24000KG

HINGED DRAWBAR: D-VALUE 155KN

(INCL.: A - 59/11 1" BOLT SET;

B - 59/10 3/4" BOLT SET;

C - 59/1 TRAILER HOOD)

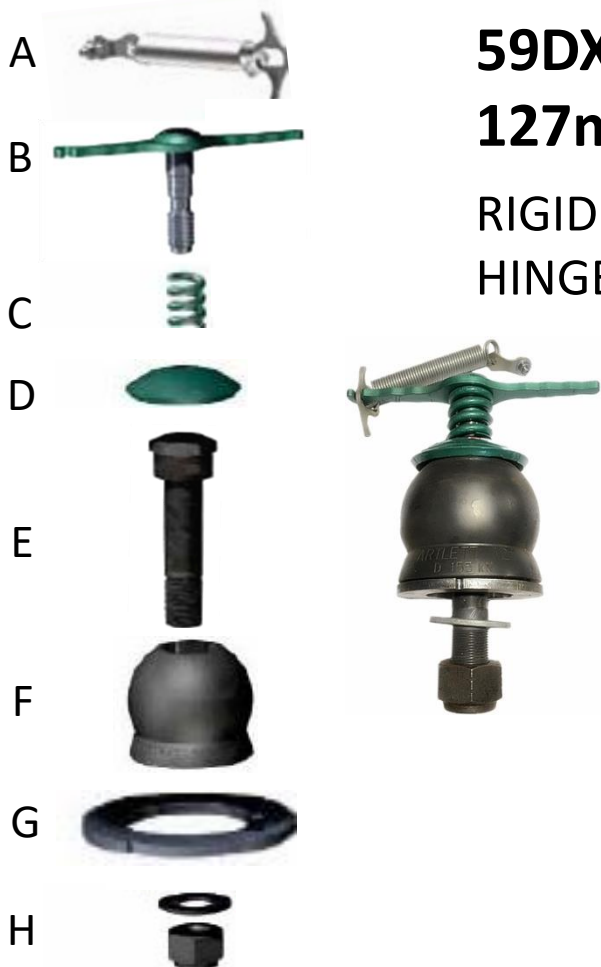

59DX
127mm BALL & TRUCK KIT

RIGID DRAWBAR: MAX. ATM 24000KG

HINGED DRAWBAR: D-VALUE 155KN

(INCL: A - 5-3/9 SAFETY SPRING;

B - 59/6 CLAMPING BOLT;

C - 59/7 COMPRESSION SPRING;

D - 59/3 CAP;

E - 59/4 MAIN BOLT;

F - 59/2 BALL;

G - 59/8 LOCATING RING;

H - 5-3/5 NYLOC NUT & WASHER)

• **127mm BALL TRAILER COUPLING**

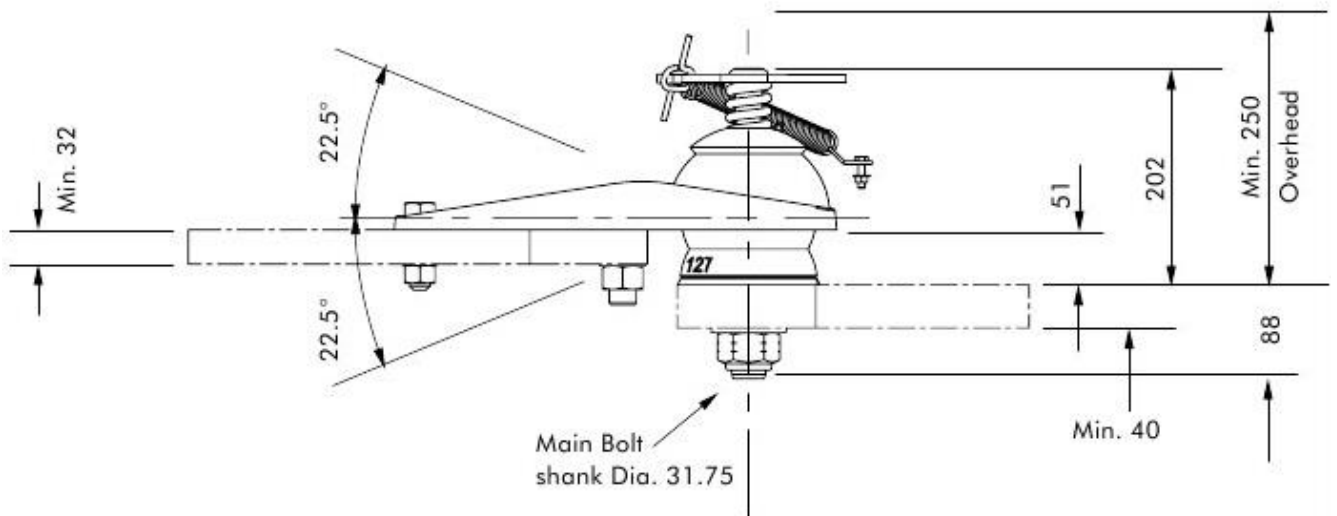
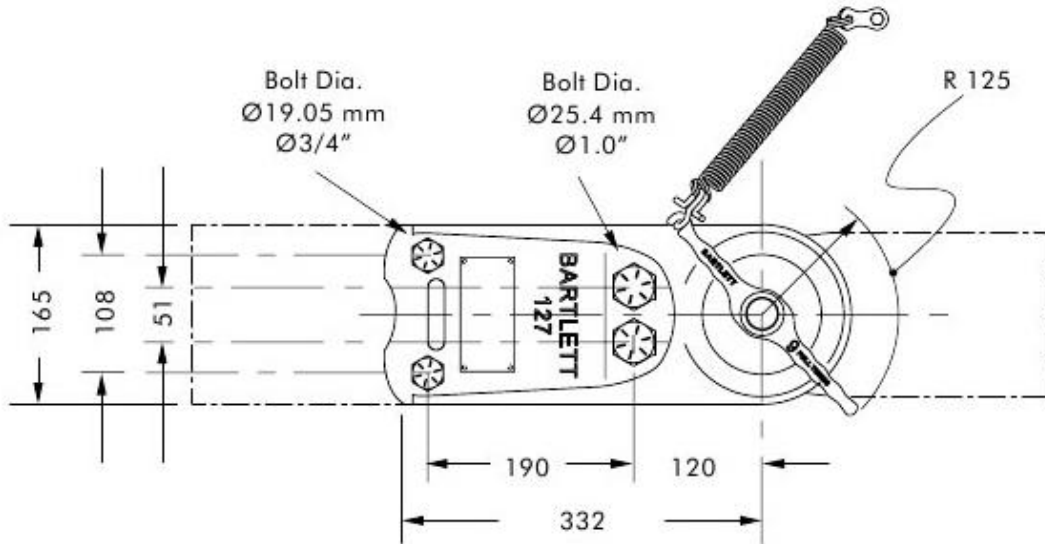

Do not scale - All measurements in mm

*Mounting lugs not included, shown for illustration purpose only - available at extra cost

*Mounting lugs must be adequately supported as dictated by professional design engineer

*DWG or DXF file available approval

• **SAFE-T-CHAIN SYSTEM**

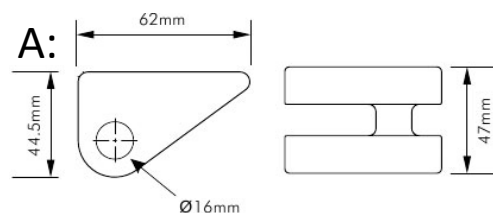

SC62-13R

TOWBAR CHAIN BRACKET SET

CAPACITY: MAX. ATM 13500KG

(INCL.: A - ATTACHMENT - HIGH TENSILE WELDABLE STEEL (2 OFF) (DIMENSIONS SEE ABOVE SCETCHES);

B - DRAWPIN ASSEMBLY - HIGH TENSILE (2 OFF);

C - DRAWPIN KEEPER (2 OFF))

SC62-13F

TRAILER CHAIN BRACKET SET

CAPACITY: MAX. ATM 13500KG



(INCL.: A - ATTACHMENT - HIGH TENSILE WELDABLE STEEL (2 OFF) (DIMENSIONS SEE ABOVE SCETCHES);

B - TRAILER PIN ASSEMBLY - HIGH TENSILE (2 OFF))

TB800/13-20

13mm x 790mm CHAIN SET

(2 LENGTHS)

PART NO.	DESCRIPTION	
0141-101	COUPLE-MATE BALL ATTACHMENT AID	 <p>The image shows a silver metal ball attachment aid with two large, flat, angled wings. Below it is its retail packaging, a black and yellow box with the 'COUPLE-MATE' logo and product details.</p>
TBS41B	TOWBALL MULTI SPANNER (BL PACK)	 <p>The image shows a blue and silver multi-spanner tool for towballs, packaged in a blue plastic sleeve with the 'SA' logo.</p>
D1090	3" MARINE BASE PLATE & LEVER	 <p>The image shows a silver metal marine base plate with a black handle lever attached to the side, used for adjusting the towball height.</p>
D1093	4" MARINE BASE PLATE & LEVER	 <p>The image shows a silver metal marine base plate with a black handle lever, similar to the 3-inch version but designed for a 4-inch towball.</p>

PART NO.	DESCRIPTION	
CM508	50MM PINTLE HOOK BALL PROTECTOR (EA)	
STPB11	BLACK SHIN PROTECTOR	
SPC50B	SHIN PROTECTOR WITH BALL COVER	
CM295	TOWBALL COUPLING WEIGHT SCALE	

• **CARTER WESCO**

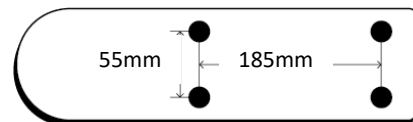

WF6

70mm BALL COUPLING c/w LEVER

WEIGHT RATING: TESTED TO 6000KG



W46/6

70mm BALL to suit 70mm COUPLING

WEIGHT RATING: TESTED TO 6000KG

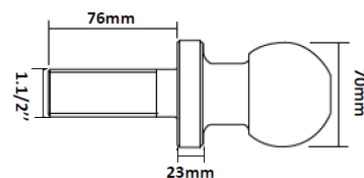

• **COUPLMATE**

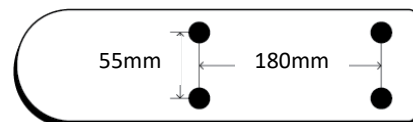

WF45

70mm BALL COUPLING c/w LEVER

WEIGHT RATING: TESTED TO 4500KG



W46

70mm BALL to suit 70mm COUPLING

WEIGHT RATING: TESTED TO 4500KG

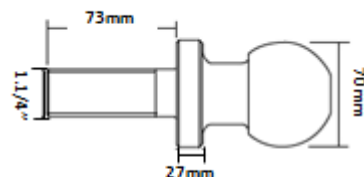

- GOOSE NECK COUPLING & BALLS**



SM300C
SM300 GOOSENECK 3" COUPLING
(TO AG USE ONLY)

WEIGHT RATING: 9000KG



GP300C
GP300 GOOSENECK 3" COUPLING
(TO AG USE ONLY)

WEIGHT RATING: 9000KG



B2516
2.5/16" TOWBALL

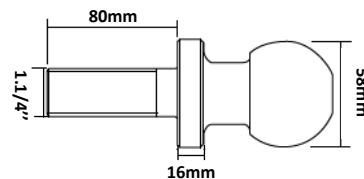

TOWING RATING: 6000KG

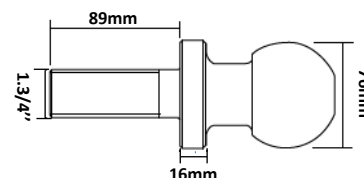

SM300B
SM300 TOWBALL 3"
(TO AG USE ONLY)

TOWING RATING: 9000KG



PART NO.	DESCRIPTION	WEIGHT RATING	
AO118	3" RING WELD ON SWIVEL COUPLING	10,000KG	
AO160	3" RING BOLT ON TELECOM COUPLING	10,000KG	
C01A3	50mm STD COUPLING 3 HOLE - BLACK	---	
CAS32Z	50mm STD COUPLING 3 HOLE - ZINC	---	
JS-CWET	50mm A-FRAME WELD ON COUPLING	---	



TB178C

1.7/8" MACHINE BALL - 2" x 7/8" SHANK

TOWING CAPACITY: 2270KG

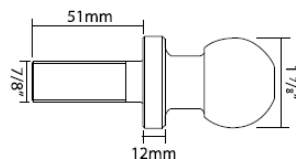

TB3562Z

50mm MACHINE BALL - 2.5" x 7/8" SHANK

TOWING CAPACITY: 3500KG

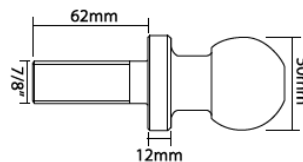

TB5080C

50mm MACHINE BALL - 3" x 7/8" SHANK

TOWING CAPACITY: 2500KG

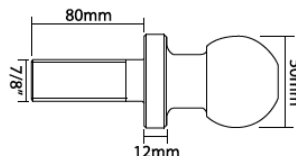

TB503T

50mm MACHINE BALL - 2" x 1" SHANK

TOWING CAPACITY: 3500KG

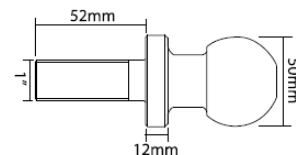

• **SA PINTLE HOOK ONLY**



	PART NO.	PARTS IN THE BOX	MODEL NUMBER	CRN	STATIC RATING (KG)
	SA89676	<ul style="list-style-type: none"> • PINTLE HOOK • BOLTS, NUTS & WASHERS • FITTING INSTRUCTION • TAG 	PH-10000	44545	10000kg

• **SA PINTLE HOOK c/w BALL**





	PART NO.	PARTS IN THE BOX	MODEL NUMBER	CRN	STATIC RATING (KG)
	SA89758	<ul style="list-style-type: none"> • PINTLE HOOK c/w BALL • BOLTS, NUTS & WASHERS • FITTING INSTRUCTION • TAG 	PH6000/ TB3500	44543 & 44544	<ul style="list-style-type: none"> • HOOK: 6000kg • BALL: 3500kg

• **SA PINTLE HOOK RECEIVER**



	PART NO.	PARTS IN THE BOX	MODEL NUMBER	CRN	STATIC RATING (KG)
	SA69021	<ul style="list-style-type: none"> • PINTLE HOOK RECEIVER • FITTING INSTRUCTION • TAG 	PHEP6000	44737	6000kg

PART NO.	DESCRIPTION	
SA89672	SAT SLIDE IN PINTLE HOOK ONLY -4.5 TON (NOT ADR APPROVED, AG USE ONLY)	
SA89751	SAT SLIDE IN PINTLE HOOK C/W 50MM BALL – 5 TON (NOT ADR, AG USE ONLY)	
SA63036	SAT 3" WELD ON RING – 10 TON (NOT ADR APPROVED, AG USE ONLY)	

SA

TRAILER

& CHASSIS EQUIPMENT

BRAKE SYSTEM



136 Port Wakefield Road, CAVAN SA 5094

Ph. 08 8262 7170 Fax. 08 8262 6123

www.satrailer.com.au

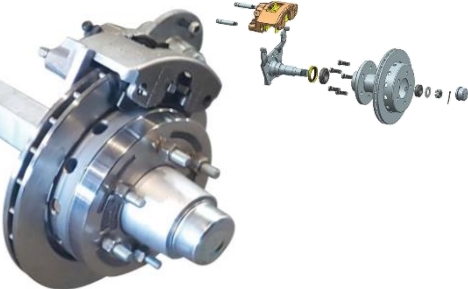
PART NO.	DESCRIPTION	
CALP-3-6K-PAD	Deemaxx Ceramic Brake Pads WEIGHT : 1.1 kg DIMENSIONS : 20 × 10 × 10 cm	
CALP-3-6K-PAD-SS	Deemaxx Ceramic Brake Pads – Stainless WEIGHT : 1.1 kg DIMENSIONS : 15 × 10 × 8 cm	
FBK.50.14	Set TLC/6 DeeMax S/S Hyd Disc Brakes (S/S calip & slip on disc) 2500kg	

SA

TRAILER

& CHASSIS EQUIPMENT

ELECTRIC BRAKE & SPARE PART









136 Port Wakefield Road, CAVAN SA 5094

Ph. 08 8262 7170 Fax. 08 8262 6123

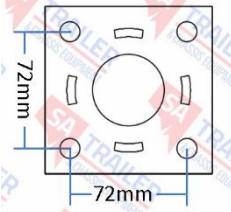
www.satrailer.com.au

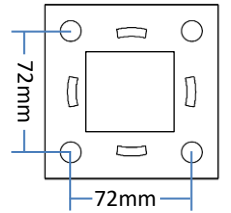
ELECTRIC BRAKE SPARE PARTS

- to suit 10'' ELECTRIC BRAKE

		PART NUMBER	DESCRIPTION
		332100S	STD ELECTRIC MOUNT PLATE – 39mm ROUND HOLE
		332150B	H/DUTY ELECTRIC MOUNT PLATE – 45mm ROUND HOLE
		FE10S42	ELECTRIC MOUNT PLATE to suit 40mm SQUARE AXLE – 42mm SQUARE HOLE
		FE10S47	ELECTRIC MOUNT PLATE to suit 45mm SQUARE AXLE – 47mm SQUARE HOLE
		FE10S52	ELECTRIC MOUNT PLATE to suit 50mm SQUARE AXLE – 52mm SQUARE HOLE

NOTE: FOR BEST RESULTS, USE JIG TO FIT MOUNT PLATES

• 10" & 12" ELECTRIC BACKPLATE – AL-KO

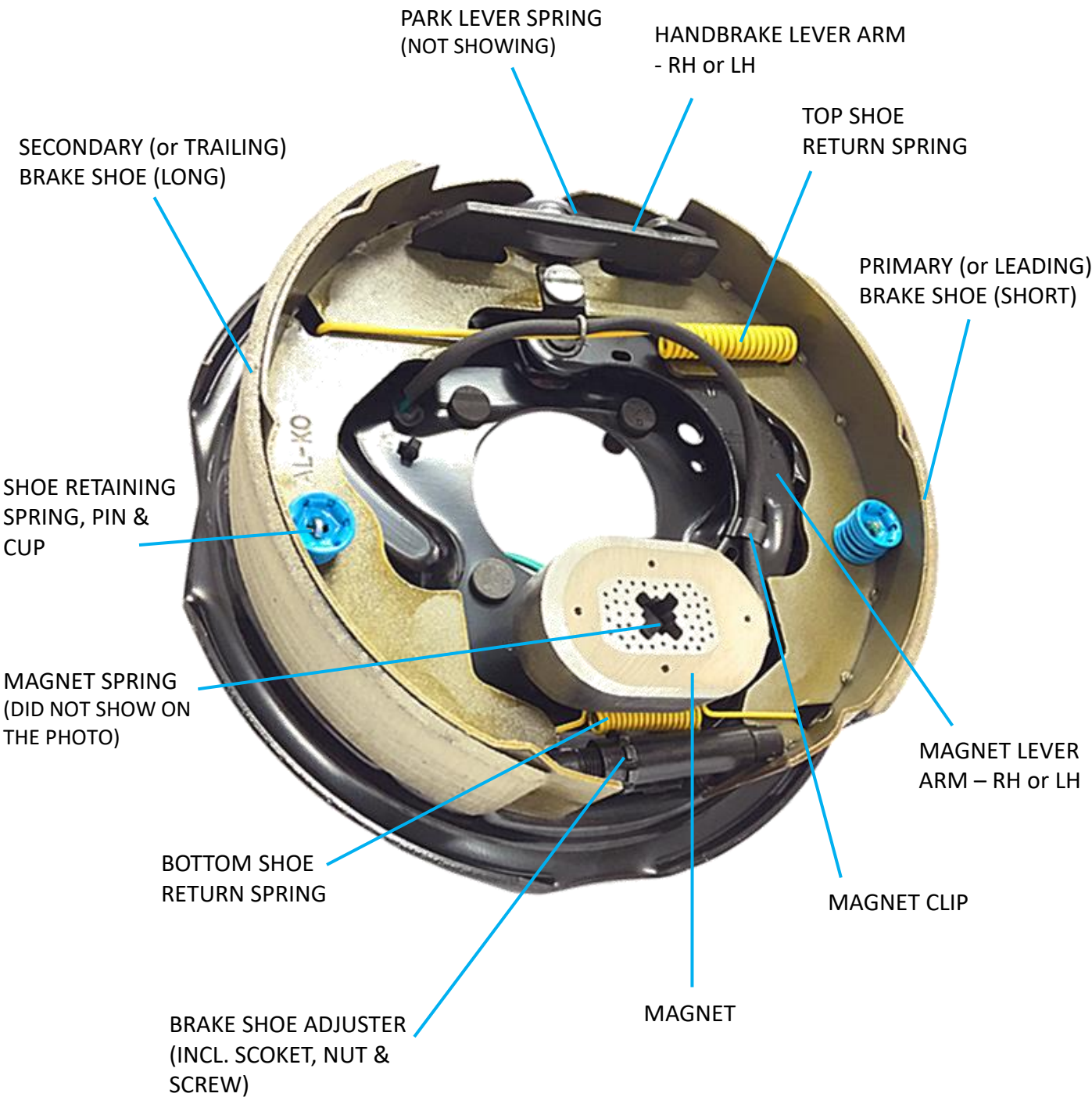

NOTE: SAMPLE BASED ON THE AK 10" RH ELECTRIC BACKPLATE

ELECTRIC BRAKE SPARE PARTS

- to suit 10" ELECTRIC BACKPLATE – AL-KO

	PART NUMBER	DESCRIPTION
	339010	AK 10" OVAL MAGNET KIT (BL PACK – incl. MAGNET, CLIP & SPRING)
	339118	AK 10" OVAL MAGNET (LOOSE)
	339015	AK 10" OVAL OFFROAD MAGNET KIT – R/H (BL PACK – incl. MAGNET, CLIP & SPRING)
	339020	AK 10" OVAL OFFROAD MAGNET KIT – L/H (BL PACK – incl. MAGNET, CLIP & SPRING)
	339255	AK 10" OVAL OFF-ROAD MAGNET – R/H (LOOSE)
	339250	AK 10" OVAL OFF-ROAD MAGNET – L/H (LOOSE)

ELECTRIC BRAKE SPARE PARTS

- to suit 10" ELECTRIC BACKPLATE – AL-KO

	PART NUMBER	DESCRIPTION
	339115	AK 10" MAGNET LEVER ARM – R/H
	339114	AK 10" MAGNET LEVER ARM – L/H
	339120/1	PAIR AK 10" ELECTRIC BRAKE SHOES to suit 1 WHEEL
	339132	AK HANDBRAKE LEVER ARM – R/H to suit 10" & 12"
	339131	AK HANDBRAKE LEVER ARM – L/H to suit 10" & 12"

ELECTRIC BRAKE

SPARE PARTS

• to suit 10" ELECTRIC BACKPLATE – AL-KO

	PART NUMBER	DESCRIPTION
	339101	AK MAGNET CIR CLIP (OLD STYLE) to suit 10" & 12"
	339102	AK MAGNET CLIP (NEW STYLE) to suit 10" & 12"
	339110	AK MAGNET SPRING to suit 10" & 12"
	339124	AK BRAKE SHOE ADJUSTER to suit 10" & 12"
	339126/7	AK SHOE RETAINING SPRING, PIN & CUP to suit 10" & 12"
	339128	AK 10" BOTTOM SHOE RETURN SPRING

ELECTRIC BRAKE SPARE PARTS



- to suit 10" ELECTRIC BACKPLATE – AL-KO

	PART NUMBER	DESCRIPTION
	339130	AK 10" TOP SHOE RETURN SPRING
	339129	AK 10" PARK LEVER SPRING
	339140	AK 12" BOTTOM SHOE RETURN SPRING

ELECTRIC BRAKE SPARE PARTS

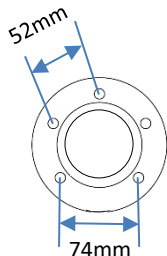
• to suit 12" ELECTRIC BACKPLATE – AL-KO



	PART NUMBER	DESCRIPTION
	BF12	12" MOUNT PLATE – 60mm HOLE
	339117	AK 12" MAGNET LEVER ARM – R/H
	339116	AK 12" MAGNET LEVER ARM – L/H
	339122/3	PAIR AK 12" ELECTRIC BRAKE SHOES to suit 1 WHEEL
	339300	AK 12" OVAL MAGNET (LOOSE) – L/H or R/H
	339355	AK 12" OVAL OFF-ROAD MAGNET (LOOSE) – R/H
	339350	AK 12" OVAL OFF-ROAD MAGNET (LOOSE) – L/H

GREASE CAPS



136 Port Wakefield Road, CAVAN SA 5094

Ph. 08 8262 7170 Fax. 08 8262 6123

www.satrailer.com.au

PART No.	DESCRIPTION		
DC1	1.3/4" Grease Cap Outer Diameter: 1.3/4" Height: 30.2mm Suit: Standard & Heavy Duty Finishing: Galv		
DC2	2" Grease Cap Outer Diameter: 2" Height: 30mm Suit: Dexter Finishing: Zinc		
DC216	2.1/16" Grease Cap Outer Diameter: 2.1/16" Height: 35mm Suit: Old "C" Type Knock In Finishing: Zinc		
DC214	2.1/4" Grease Cap Outer Diameter: 2.1/4" Height: 37mm Finishing: Zinc		
DC59	59mm Grease Cap Outer Diameter: 59mm Height: 34mm Suit: Simplicity Finishing: Zinc		
DC62	62mm Grease Cap Outer Diameter: 62mm Height: 35mm Suit: Dexter Finishing: Zinc		

PART No.	DESCRIPTION		
GC25	<p>2.1/2" Grease Cap Outer Diameter: 2.1/2" Height: 37mm Suit: 2 Ton Finishing: Zinc</p>		
DC70	<p>70mm or 2.3/4" Grease Cap Outer Diameter: 70mm Height: 38.5mm Suit: Dexter Finishing: Zinc</p>		
GC3	<p>3" Grease Cap Outer Diameter: 3" Height: 46mm Suit: 3 Ton Finishing: Raw Material</p>		
DC80	<p>80mm Grease Cap Outer Diameter: 80mm Height: 39.5mm Suit: Agricultural Finishing: Zinc</p>		
DC90	<p>90mm Grease Cap Outer Diameter: 90mm Height: 43mm Suit: Agricultural Finishing: Zinc</p>		



JOCKEY WHEELS & PARTS

- **AL-KO**
- **SAT**
- **MISCELLANEOUS**

136 Port Wakefield Road, CAVAN SA 5094
Ph. 08 8262 7170 Fax. 08 8262 6123
www.satrailer.com.au



626100
6 x 2 JOCKEY WHEEL c/w CLAMP

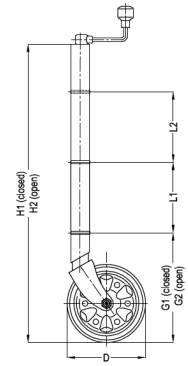

WEIGHT (KG)	SURFACE FINISH	STATIC CAPACITY (KG)	OUTER TUBE DIAMETER	D (mm)	H 1 (mm)	H 2 (mm)	G 1 (mm)	G 2 (mm)	L 1 (mm)
5.5	ZINC PLATED	400KG	48mm	150	507	772	202	467	182



628100
8 x 2 JOCKEY WHEEL c/w CLAMP

WEIGHT (KG)	SURFACE FINISH	STATIC CAPACITY (KG)	OUTER TUBE DIAMETER	D (mm)	H 1 (mm)	H 2 (mm)	G 1 (mm)	G 2 (mm)	L 1 (mm)
7	ZINC PLATED	400KG	48mm	200	567	832	262	522	182



628325
8 x 2 EX. HEIGHT JOCKEY WHEEL c/w CLAMP

WEIGHT (KG)	SURFACE FINISH	STATIC CAPACITY (KG)	OUTER TUBE DIAMETER	D (mm)	H 1 (mm)	H 2 (mm)	G 1 (mm)	G 2 (mm)	L 1 (mm)
7	ZINC PLATED	400KG	48mm	200	730	995	370	635	132

Helpful Hint:
Use a large wheel for soft ground!



626204

6 x 2 JOCKEY WHEEL c/w SMALL DOUBLE LOCKING PIN BRACKET

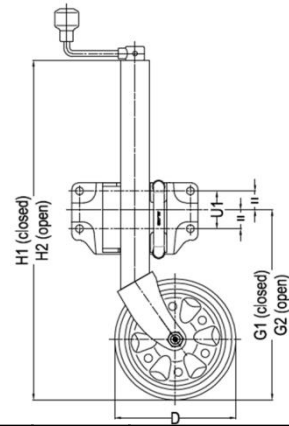

WEIGHT (KG)	SURFACE FINISH	STATIC CAPACITY (KG)	OUTER TUBE DIAMETER	D (mm)	H 1 (mm)	H 2 (mm)	G 1 (mm)	G 2 (mm)	U (mm) HOLE SIZE (ø14)
									U 1
									FOR DRAW BAR DEPTH
									50mm
7	ZINC PLATED	400KG	48mm	150	510	760	300	525	63



628204

8 x 2 JOCKEY WHEEL c/w SMALL DOUBLE LOCKING PIN BRACKET

WEIGHT (KG)	SURFACE FINISH	STATIC CAPACITY (KG)	OUTER TUBE DIAMETER	D (mm)	H 1 (mm)	H 2 (mm)	G 1 (mm)	G 2 (mm)	U (mm) HOLE SIZE (ø14)
									U 1
									FOR DRAW BAR DEPTH
									50mm
8.5	ZINC PLATED	400KG	48mm	200	570	820	310	560	63

Helpful Hint:

Use a large wheel for soft ground!



628200XP3
8 x 2 SOLID TYRE JOCKEY
WHEEL c/w 3 BOLT DOUBLE
LOCKING PIN SWIVEL BRACKET

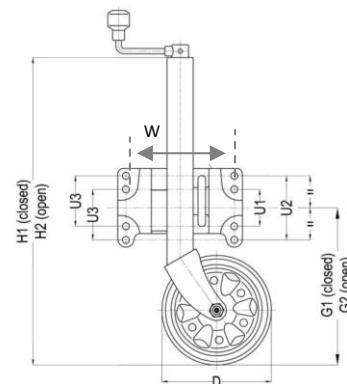

WEIGHT (KG)	SURFACE FINISH	STATIC CAPACITY (KG)	OUTER TUBE DIAMETER	D (mm)	H 1 (mm)	H 2 (mm)	G 1 (mm)	G 2 (mm)	W (mm)	U (mm) HOLE SIZE (ø14)		
										U 1	U 2	U 3
										FOR DRAW BAR DEPTH		
										50 mm	100 mm	75 mm
8.5	ZINC PLATED	400KG	48mm	200	570	820	305	522	185	63	113	88



623660XP3
250 x 80 SOLID TYRE JOCKEY
WHEEL c/w 3 BOLT DOUBLE
LOCKING PIN SWIVEL BRACKET

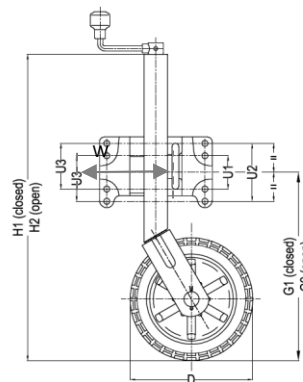

WEIGHT (KG)	SURFACE FINISH	STATIC CAPACITY (KG)	OUTER TUBE DIAMETER	D (mm)	H 1 (mm)	H 2 (mm)	G 1 (mm)	G 2 (mm)	W (mm)	U (mm) HOLE SIZE (ø14)		
										U 1	U 2	U 3
										FOR DRAW BAR DEPTH		
										50 mm	100 mm	75 mm
11	ZINC PLATED	400KG	48mm	250	630	880	320	570	185	63	113	88



628500
8 x 2 PREMIUM SIDE WIND JOCKEY
WHEEL c/w EXTRA WIDE CLAMP

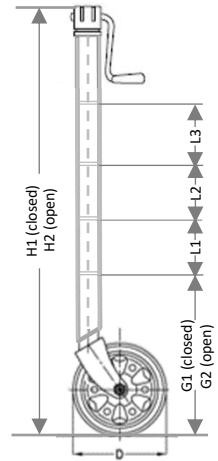

WEIGHT (KG)	SURFACE FINISH	STATIC CAPACITY (KG)	OUTER TUBE DIAMETER	D (mm)	H 1 (mm)	H 2 (mm)	G 1 (mm)	G 2 (mm)	L 1 (mm)	L 2 (mm)	L 3 (mm)
9.1	ZINC PLATED	400KG	48mm	200	771	1037	320	586	85	85	85



621250
250 x 80 SOLID TYRE POWER
MOVER JOCKEY WHEEL c/w CLAMP

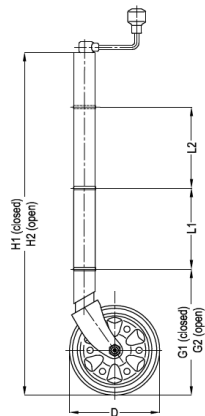

WEIGHT (KG)	SURFACE FINISH	STATIC CAPACITY (KG)	DYNAMIC CAPACITY (KG)	OUTER TUBE DIAMETER	D (mm)	H 1 (mm)	H 2 (mm)	G 1 (mm)	G 2 (mm)	L 1 (mm)	L 2 (mm)
14.7	ZINC PLATED	350KG	150KG	48mm	245	625	875	335	585	85	85

Helpful Hint: Use a large wheel for soft ground!

626050

T/T 6 x 2 LIGHT DUTY JOCKEY WHEEL c/w CLAMP

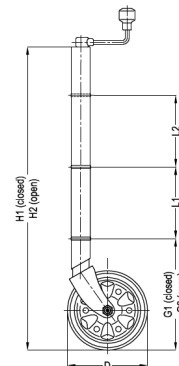

WEIGHT (KG)	SURFACE FINISH	STATIC CAPACITY (KG)	OUTER TUBE DIAMETER	D (mm)	H 1 (mm)	H 2 (mm)	G 1 (mm)	G 2 (mm)	L 1 (mm)
5	ZINC PLATED	350KG	48mm	150	510	760	202	457	180

629250TT

T/T 250 x 80 ZINC PLATED SOLID TYRE JOCKEY WHEEL c/w CLAMP



WEIGHT (KG)	SURFACE FINISH	STATIC CAPACITY (KG)	OUTER TUBE DIAMETER	D (mm)	H 1 (mm)	H 2 (mm)	G 1 (mm)	G 2 (mm)	L 1 (mm)
8	ZINC PLATED	350KG	48mm	245	635	885	325	575	180

Helpful Hint:

Use a large wheel for soft ground!

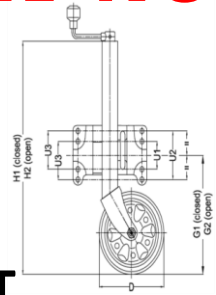

626190

T/T 6 x 2 LIGHT DUTY JOCKEY WHEEL
c/w LARGE DOUBLE LOCKING PIN BRACKET

WEIGHT (KG)	SURFACE FINISH	STATIC CAPACITY (KG)	OUTER TUBE DIAMETER	D (mm)	H 1 (mm)	H 2 (mm)	G 1 (mm)	G 2 (mm)	U (mm) HOLE SIZE (ø14)		
									U 1	U 2	U 3
									FOR DRAW BAR DEPTH		
									50 mm	100 mm	75 mm
6.75	ZINC PLATED	350KG	48mm	150	510	760	310	560	63	113	88

628200SLTT

T/T 8 x 2 ZINC PLATED JOCKEY WHEEL
c/w LARGE DOUBLE LOCKING PIN BRACKET

WEIGHT (KG)	SURFACE FINISH	STATIC CAPACITY (KG)	OUTER TUBE DIAMETER	D (mm)	H 1 (mm)	H 2 (mm)	G 1 (mm)	G 2 (mm)	U (mm) HOLE SIZE (ø14)		
									U 1	U 2	U 3
									FOR DRAW BAR DEPTH		
									50 mm	100 mm	75 mm
7.5	ZINC PLATED	350KG	48mm	200	570	820	310	560	63	113	88

629250SLTT

**T/T 250 x 80 ZINC PLATED
JOCKEY WHEEL c/w LARGE
DOUBLE LOCKING PIN BRACKET**

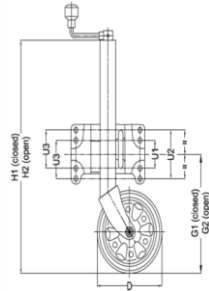

WEIGHT (KG)	SURFACE FINISH	STATIC CAPACITY (KG)	OUTER TUBE DIAMETER	D (mm)	H 1 (mm)	H 2 (mm)	G 1 (mm)	G 2 (mm)	U (mm) HOLE SIZE (ø14)		
									U 1	U 2	U 3
									FOR DRAW BAR DEPTH		
									50 mm	100 mm	75 mm
10.5	ZINC PLATED	350KG	48mm	245	630	880	395	645	63	113	88

622455

500KG FLIP UP JOCKEY WHEEL c/w BRACKET

WEIGHT (KG)	SURFACE FINISH	STATIC CAPACITY (KG)	DYNAMIC CAPACITY (KG)	WHEEL DIM. & WIDTH (mm)
10	ZINC PLATED	500KG	300KG	200 x 50

DIM. A		DIM. B		DIM. C (MAX. TRAVEL) (mm)	DIM. D (OUTER TUBE DIAMETER)	DIM. E (mm)
MIN. (mm)	MAX. (mm)	MIN. (mm)	MAX. (mm)			
730	975	840	840	245	60mm	410

DIM. F (mm)	DIM. G (mm)	DIM. H (mm)	DIM. K (mm)	DIM. L (mm)	DIM. M (MIN. mm)	DIM. N (mm)
300	145	330	235	90	75	140

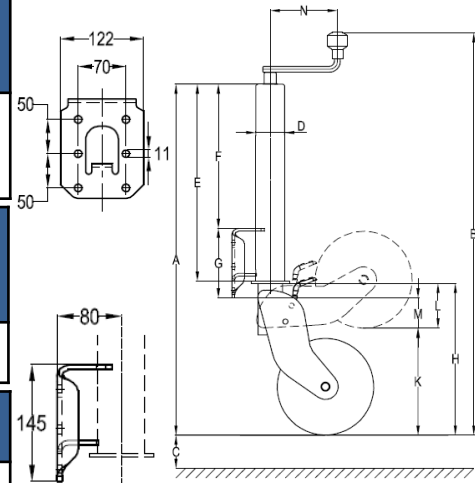

629900 JOCKEY WHEEL CLAMP

WEIGHT (KG)	SURFACE FINISH	OUTER TUBE DIAMETER	A (mm)	B ϕ (mm)
1	ZINC PLATED	48mm	150	13

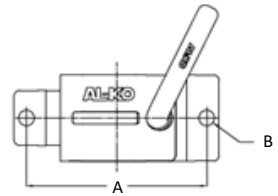

629920 LARGE DOUBLE LOCKING PIN BRACKET

WEIGHT (KG)	SURFACE FINISH	STATIC CAPACITY (KG)	OUTER TUBE DIAMETER	A (mm)	B (mm)	C (mm)	D (mm)
2.5	ZINC PLATED	400KG	48mm	185	88	63	113

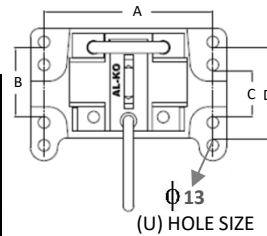

629923 SWIVEL BRACKET 3 BOLT LARGE

WEIGHT (KG)	SURFACE FINISH	STATIC CAPACITY (KG)	OUTER TUBE DIAMETER	A (mm)	B (mm)	C (mm)	D (mm)
2.65	ZINC PLATED	400KG	48mm	185	88	63	113

629935 DOUBLE LOCKING PIN BRACKET c/w CLAMP

WEIGHT (KG)	SURFACE FINISH	OUTER TUBE DIAMETER	A (mm)	B (mm)	C (mm)	D (mm)
3.3	ZINC PLATED	48mm	185	75	50	100



629600
6 x 2 SOLID
RUBBER WHEEL



629888
8 x 2 STEEL/
RUBBER WHEEL



629850
250 x 80 STEEL/
RUBBER WHEEL

Helpful Hint: Use a large wheel for soft ground!

PART NO.	DESCRIPTION	
626262	JOCKEY WHEEL U.BOLT KIT (75mm x 75mm)	
626260	JOCKEY WHEEL U.BOLT KIT (100mm x 75mm)	
629910	AK JOCKEY WHEEL MANOEUVRING HANDLE	
629915	AK JOCKEY WHEEL PREMIUM WIDE CLAMP (SPACING: 150mm x 50mm ; HOLE SIZE: 13mm)	
629602	STD. THRUST BEARING	
629601GS	JOCKEY WHEEL HANDLE c/w GRUB SCREW	
629601RP	JOCKEY WHEEL HANDLE c/w ROLL PIN	
629951	CLAMP HANDLE & BOLT	
629605	SCREWED SHAFT ONLY	



SABD-03A

STATIC CAPACITY (KG):
300

540mm
(CLOSED HEIGHT)

810mm
(OPEN HEIGHT)

170mm

6" JOCKEY WHEEL c/w CLAMP



SABD-03A2

STATIC CAPACITY (KG):
300

540mm
(CLOSED HEIGHT)

810mm
(OPEN HEIGHT)

170mm

6" JOCKEY WHEEL c/w LARGE DOUBLE LOCKING PIN BRACKET



SABD-03B

STATIC CAPACITY (KG):
300

570mm
(CLOSED HEIGHT)

835mm
(OPEN HEIGHT)

165mm

6 x 2" SIDE WIND JOCKEY WHEEL c/w DOUBLE LOCKING PIN BRACKET



SABD-03G1

STATIC CAPACITY (KG):
300

600mm
(CLOSED HEIGHT)

870mm
(OPEN HEIGHT)

230mm

8" JOCKEY WHEEL c/w LARGE DOUBLE LOCKING PIN BRACKET



**10" PNEUMATIC JOCKEY WHEEL
 c/w CLAMP**

**10" PNEUMATIC JOCKEY WHEEL c/w
 LARGE DOUBLE LOCKING PIN BRACKET**

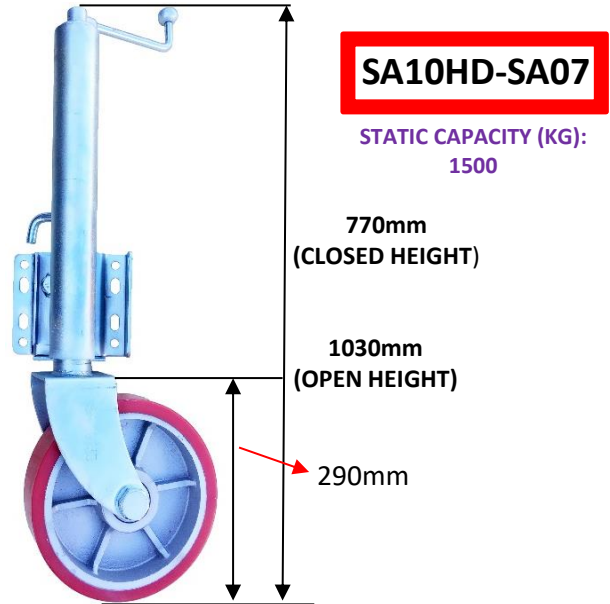
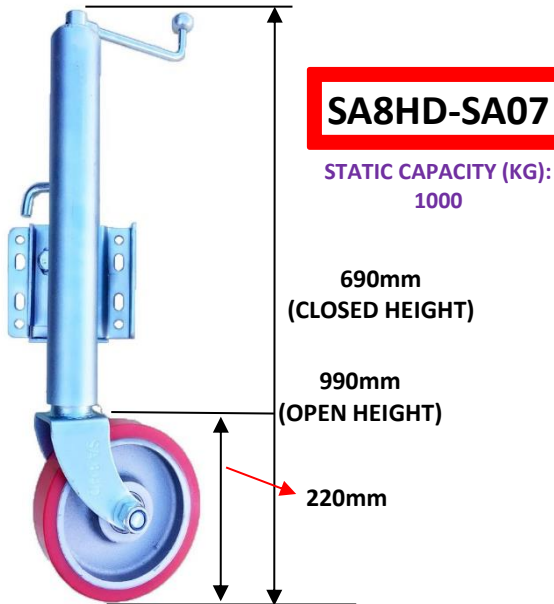

**8 x 2 HEAVY DUTY JOCKEY WHEEL
 c/w SINGLE LOCKING PIN BRACKET**

**10 x 2 HEAVY DUTY JOCKEY WHEEL
 c/w SINGLE LOCKING PIN BRACKET**

PART NO.	DESCRIPTION	
SASTB	SA SMALL THRUST BEARING	
SALTB	SA LARGE THRUST BEARING	
SA810SS/SN	SA H/D SCREWED SHAFT & NUT	
SABDWH	SA J/WHEEL HANDLE TO SUIT SABD J/WHEEL	
SA8WH	SA H/D J/WHEEL HANDLE TO SUIT SA8HD	
SA10WH	SA H/D J/WHEEL HANDLE TO SUIT SA10HD	
SA07	SINGLE LOCKING PIN BRACKET	
SA200X50	200 x 50 (8'') CAST/POLY WHEEL	
SA250X60	250 x 60 (10'') CAST/POLY WHEEL	
SA08	SA DOUBLE LOCKING PIN BRACKET (4 BOLTS) WITH UBOLTS T/S150X50 DRAWBAR	



JW-HDLP

EASYLIFT (EL.) 8 x 2 HEAVY DUTY JOCKEY WHEEL c/w SINGLE LOCKING PIN BRACKET

STATIC CAPACITY (KG): 1500KG

J/WHEEL SPARE PARTS

PART NO.	DESCRIPTION	WEIGHT RATING	
323302-00	SINGLE LOCKING PIN BRACKET	--	
SRNW2005016	8 x 2 SOLID RUBBER WHEEL	800KG	
SRSW2504825	10 x 2 ALLI/RUBBER WHEEL	2000KG	
323307-01	EL. H/D JOCKEY WHEEL HANDLE (GRUB SCREW)	--	
323305-10	EL. H/D SCREWED SHAFT ONLY	--	

PART NO.	DESCRIPTION	WEIGHT RATING	
323306-10	EL. H/D SCREWED SHAFT NUT	--	
FCL8	JOCKEY WHEEL CLAMP WITH 8 HOLES	--	
JW-SSSS	TUBE MOUNT SWIVEL BRACKET - SMALL	--	
JW-SSSL	TUBE MOUNT SWIVEL BRACKET - LARGE	--	

LIGHTS & ACCESSORIES

- LED AUTO LAMPS
- NARVA
- MAXILITE
- PROJECTA
- WHITE VISION









136 Port Wakefield Road, CAVAN SA 5094

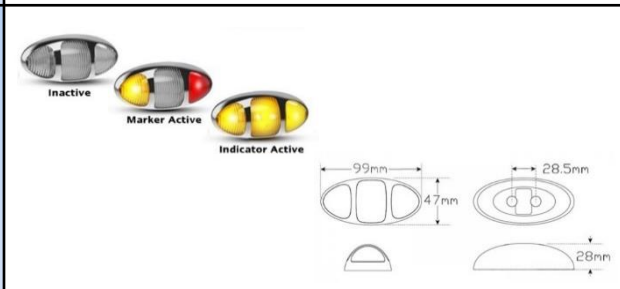
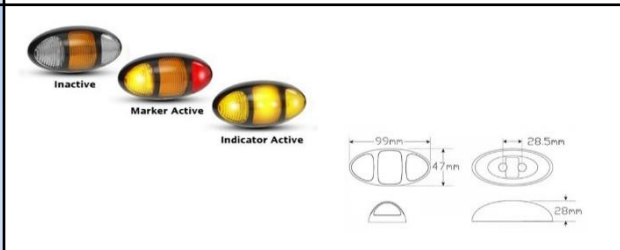
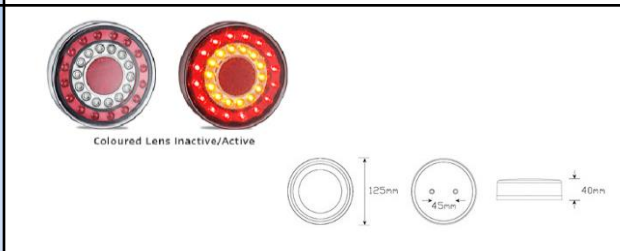
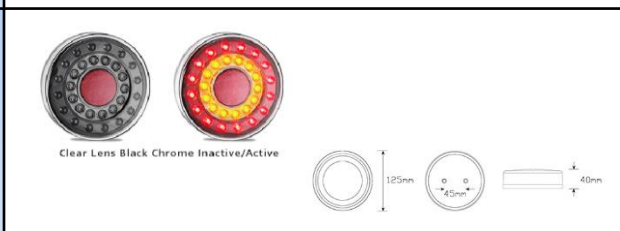
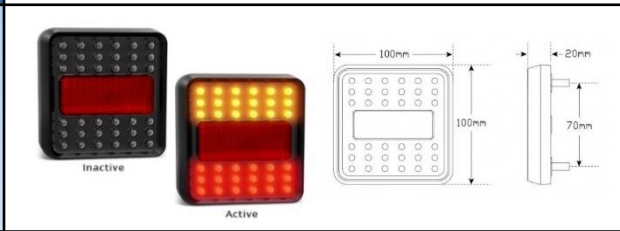



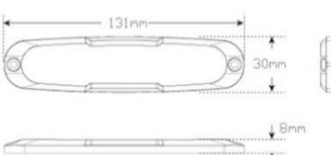
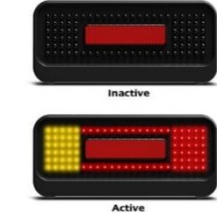
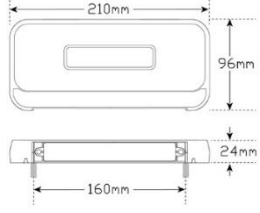
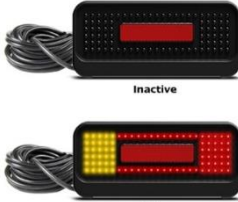
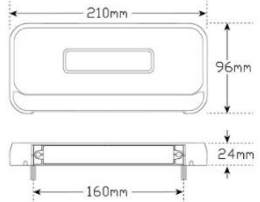

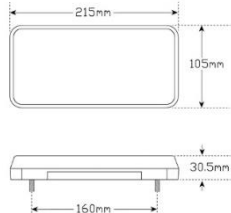

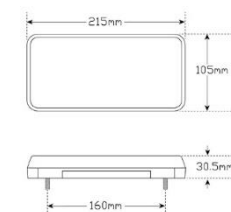



Ph. 08 8262 7170 Fax. 08 8262 6123











www.satrailer.com.au



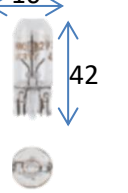

PART NO.	DESCRIPTION
211BAR2	12V SQU. LED STOP/TAIL/IND./ REFLECTOR LAMP - TWIN BLISTER
200BARM	12-24V RECT. LED DOUBLE LINED STOP/TAIL/INDICATOR - SINGLE BLISTER
MAXILAMPC 1XCE	12-24V RD. LED STOP/TAIL/IND/REFLECTOR WITH CLEAR LENS- SINGLE BLISTER
MAXILAMPC 1XCE3M	12-24V RD. LED STOP/TAIL/IND/REFLECTOR WITH CLEAR LENS- 3M TAPE
97ARIM	TWIN FUN SIDE IND WITH AMBER/RED (99 x 47 x 28mm (BLACK)) BLISTER
97CARIM	TWIN FUN SIDE IND WITH AMBER/RED (99 x 47 x 28mm (CHROME)) BLISTER







PART NO.	DESCRIPTION		
12ARM-2	12-24V MULTIVOLT LED S/T/IND LAMP CLEAR LENS (131 x 30 x 8 mm) BLISTER	 <p>Inactive</p> <p>Active</p>	
210BARLP2	RHS & LHS LAMPS WITH 40cm CABLE PACKAGED IN TWIN BLISTER	 <p>Inactive</p> <p>Active</p>	
210BARLP2-10M	RHS & LHS LAMPS WITH 10m CABLE PACKAGED IN TWIN BLISTER	 <p>Inactive</p> <p>Active</p>	
215ARLP2	12V RECT. LED STOP/TAIL/IND/LIC/REFLECTOR LAMP - TWIN BLISTER	 <p>Inactive</p> <p>Active</p>	
216ARLP2	12V RECT. LED STOP/TAIL/IND/LICENCE LAMP - TWIN BLISTER	 <p>Inactive</p> <p>Active</p>	

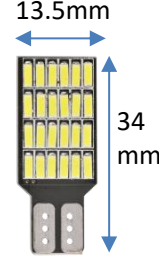

PART NO.	DESCRIPTION		PART NO.	DESCRIPTION	
47254	FESTOON 12V GLOBE: 12V x 5W		47156	BAYONET 12V GLOBE: 12V x 32CP (SINGLE POLE)	
47258	FESTOON 12V GLOBE: 12V x 5W		47382	BAYONET 12V GLOBE: 12V x 21W (SINGLE POLE)	
47266	FESTOON 12V GLOBE: 12V x 10W		47207	BAYONET 12V GLOBE: 12V x 5W (SINGLE POLE)	
47269	FESTOON 12V GLOBE: 12V x 10W		47209	BAYONET 12V GLOBE: 12V x 5W (DOUBLE POLE)	
47270	FESTOON 12V GLOBE: 12V x 18W (15x41mm)		47233	BAYONET 12V GLOBE: 12V x 4W (SINGLE POLE)	
47003	BAYONET 12V GLOBE: 12V x 15CP (SINGLE POLE)		47281	BAYONET 12V GLOBE: 12V x 2W (SINGLE POLE)	
47005	BAYONET 12V GLOBE: 12V x 21/21W (DOUBLE POLE)		47335	BAYONET 12V GLOBE: 12V x 21W (DOUBLE POLE)	

PART NO.	DESCRIPTION		PART NO.	DESCRIPTION	
47380	BAYONET 12V GLOBE: 12V x 21/5W (DOUBLE POLE)		47336	BAYONET 24V GLOBE: 24V x 21/5W (DOUBLE POLE)	
47643	BAYONET 12V GLOBE: 12V x 3W (SINGLE POLE)		47286	WEDGE 12V GLOBE: 12V x 1.2W (WEDGE)	
47989	BAYONET 12V GLOBE: 12V x 6W (SINGLE POLE)		47501	WEDGE 12V GLOBE: 12V x 5W (WEDGE)	
47260	FESTOON 24V GLOBE: 24V x 5W		47526	WEDGE 12V GLOBE: 12V x 21CP (WEDGE)	
47653	FESTOON 24V GLOBE: 24V x 5W		47333	BAYONET 24V GLOBE: 24V x 32CP (DOUBLE POLE)	
47988	FESTOON 24V GLOBE: 24V x 18W				

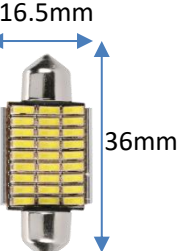
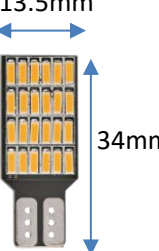



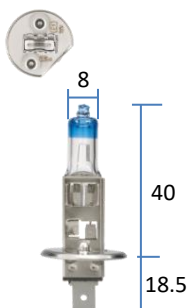
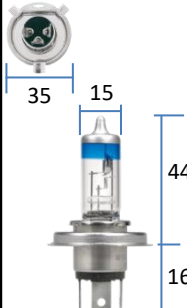
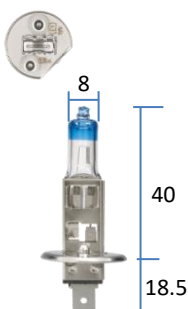

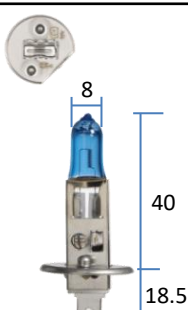
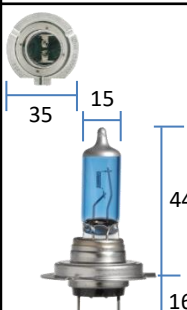
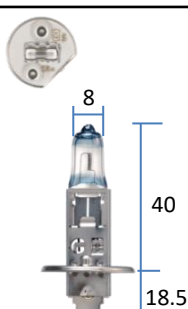
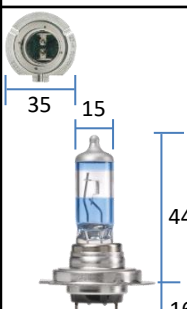



PART NO.	DESCRIPTION		PART NO.	DESCRIPTION	
18444	H4 12/24V LED CONVERSION KIT		48382BL2	12V 60/55W H4 P43T Performance Globes – PLUS150 (2 per BL Pack)	
18447	H7 12/24V LED CONVERSION KIT		48386BL2	12V 55W H7 PX26D Performance Globes – PLUS150 (2 per BL Pack)	
48396BL2	H7 12V 55W PX26D PLUS200 BL2				

PART NO.	DESCRIPTION		PART NO.	DESCRIPTION	
18020BL	HP 12V LED Festoon Globes – Day White (2 per BL Pack) Globe Type: T-10mm		18082BL	HP 12V LED Wedge Globes – Cool White (2 per BL Pack) Globe Base/Type: W2 x 15d, T-15mm	
18022BL	HP 12V LED Festoon Globes – Cool White (2 per BL Pack) Globe Type: T-10mm		18062BL	HP 12V LED Wedge Globes – Cool White (2 per BL Pack) Globe Base/Type: W2.1 x 9.5d, T-10mm	
18030BL	HP 12V LED Festoon Globes – Cobalt Blue (2 per BL Pack) Globe Type: T-10mm		18070BL	HP 12V LED Wedge Globes – Cobalt Blue (2 per BL Pack) Globe Base/Type: W2.1 x 9.5d, T-10mm	
18040BL	HP 12V LED Festoon Globes – Cool White (2 per BL Pack) Globe Type: SV8-5.8		18080BL	HP 12V LED Wedge Globes – Day White (2 per BL Pack) Globe Base/Type: W2 x 15d, T-15mm	











*****Warm Red Colour Also Available in Festoon & Wedge Globes on Request.*****









PART NO.	DESCRIPTION	(mm)	PART NO.	DESCRIPTION	(mm)
48340BL2	12V 55W H1 PLUS 100 (P14.5s) PERFORMANCE GLOBES (2 per BL Pack)		48346BL2	12V 55W H7 PLUS 100 (PX26d) PERFORMANCE GLOBES (2 per BL Pack)	
48360BL2	12V 55W H1 PLUS 120 (P14.5s) PERFORMANCE GLOBES (2 per BL Pack)		48366BL2	12V 55W H7 PLUS 120 (PX26d) PERFORMANCE GLOBES (2 per BL Pack)	
48470BL2	12V 55W H1 INTENSE PLUS 30 (P14.5s) PERFORMANCE GLOBES (2 per BL Pack)		48476BL2	12V 55W H7 INTENSE PLUS 30 (PX26d) PERFORMANCE GLOBES (2 per BL Pack)	
48530BL2	12V 55W H1 BLUE PLUS 110 (P14.5s) PERFORMANCE GLOBES (2 per BL Pack)		48535BL2	12V 55W H7 BLUE PLUS 110 (PX26d) PERFORMANCE GLOBES (2 per BL Pack)	





AFTER-MARKET TERMINALS















PART NO.	DESCRIPTION	TAB OR DIA. SIZE		PART NO.	DESCRIPTION	TAB OR DIA. SIZE	
56020BL	Male Blade Terminal - 2.5 - 3mm, Red (14 per Pack)	6.3 x 0.8 mm or 1/4'		56034BL	Female Blade Terminal - 2.5 - 3mm, RED (18 per Pack)	6.3 x 0.8 mm or 1/4'	
56022BL	Male Blade Terminal - 4mm, Blue (14 per Pack)			56036BL	Female Blade Terminal - 4mm, Blue (14 per Pack)		
56024BL	Male Blade Terminal - 5 - 6mm, Yellow (11 per Pack)			56038BL	Female Blade Terminal - 5 - 6mm, Yellow (12 per Pack)		
56030BL	2-Way M/F Connector - 2.5 - 3mm, Red (10 per Pack)	6.3 x 0.8 mm or 1/4'		56042BL	Female Blade Terminal - 2.5 - 3mm, RED (10 per Pack)	6.3 x 0.8 mm or 1/4'	
56032BL	2-Way M/F Connector - 4mm, Blue (10 per Pack)			56044BL	Female Blade Terminal - 4mm, Blue (10 per Pack)		



AFTER-MARKET TERMINALS

PART NO.	DESCRIPTION	TAB or DIA. SIZE		PART NO.	DESCRIPTION	TAB or DIA. SIZE	
56046BL	Male Bullet Terminal - 2.5 - 3mm, Red (14 per Pack)	4m m or 5/32 "		56060BL	Wire Tap Connector - 3 - 4mm, White (6 per Pack)	-	
56048BL	Male Bullet Terminal - 4mm, Blue (14 per Pack)	5m m or 3/16 "		56080BL	Ring Terminal - 4mm, Blue (20 per Pack)	6.3 mm or 1/4' ,	
56050BL	Female Bullet Terminal - 2.5 - 3mm, Red (12 per Pack)	4m m or 5/32 "		56082BL	Ring Terminal - 4mm, Blue (14 per Pack)	8.4 mm or 5/1 6"	
56052BL	Female Bullet Terminal - 4mm, Blue (11 per Pack)	5m m or 3/16 "		56088BL	Ring Terminal - 5 - 6mm, Yellow (12 per Pack)	6.3 mm or 1/4' ,	
56054BL	Cable Joiner - 2.5 - 3mm, RED (15 per Pack)	-		56090BL	Ring Terminal - 5 - 6mm, Yellow (10 per Pack)	8.4 mm or 5/1 6"	
56056BL	Cable Joiner - 4mm, Blue (14 per Pack)	-		***P.S.: Other Sizes Of Terminals or Connectors Are Available on Request.***			

PART NO.	DESCRIPTION		PART NO.	DESCRIPTION	
18424	H4 SUREFIT LED GLOBES (2)		18427P	H7 SF PROJECTOR GLOBES (2)	
18427	H7 SUREFIT LED GLOBES (2)		18428	H8/9/11 SUREFIT LED GLOBES (2)	
56146	3mm MALE BULLETT RED TERMINALS (100/PACK)		56150	3mm FEMALE BULLETT RED TERMINALS (100/PACK)	
56176	4mm BLUE 5/32" RING TERMINALS (100/PACK)		56182	4mm BLUE 5/16" RING TERMINALS (100/PACK)	















PART NO.	DESCRIPTION		PART NO.	DESCRIPTION	
57200BL	H/Duty 50 Amp Connector Housing & Copper Terminals - Gray (BL pack)	 <p>19 mm</p> <p>48L x 36W x 16T (mm)</p>	57215BL	H/Duty 175 Amp Connector Housing & Copper Terminals - Gray (BL pack)	 <p>28.5 mm</p> <p>79L x 52W x 25T (mm)</p>
57200	H/Duty 50 Amp Connector Housing & Terminals		57215	H/Duty 175 Amp Connector Housing & Terminals	

PART NO.	DESCRIPTION		PART NO.	DESCRIPTION	
82185	7 PIN LARGE ROUND "QUICKFIT" PLUG (PLASTIC)		93602	12V LED 3 IN 1 LIGHT (NO LICENCE PLATE)	 155x76x40
82185/20	7 PIN LARGE ROUND BULK "QUICKFIT" PLUG (PLASTIC)	 (20/PACK)	93604	9-30V LED 3 IN 1 LIGHT (NO LICENCE PLATE)	 155x76x40
82235	7 PIN LARGE ROUND TO 7 PIN FLAT ADAPTOR		93606	12V LED 3 IN 1 LIGHT c/w LICENCE PLATE	 155x76x40
82245	7 PIN FLAT TO 7 PIN LARGE ROUND ADAPTOR		93608	9-30V LED 3 IN 1 LIGHT c/w LICENCE PLATE	 155x76x40
85320A	AMBER LED MAGNETIC BEACON (BATTERY OPERATED)		93630	12V LED 3 IN 1 SLIMLINE LIGHT (NO LICENCE PLATE)	 156x81x26
93402	12V LED 3 IN 1 LIGHT (NO LICENCE PLATE)	 108x108x35	93634	12V LED 3 IN 1 SLIMLINE LIGHT c/w LICENCE PLATE	 156x81x26
93406	12V LED 3 IN 1 LIGHT c/w LICENCE PLATE	 108x108x35	94210	9-33V LED 3 IN 1 LIGHT c/w REVERSE LIGHT	 284x100x37







PART NO.	DESCRIPTION		PART NO.	DESCRIPTION	
82042	FLAT 7 PIN BASE (PLASTIC)		82072	FLAT 12 PIN BASE	
82052	7 PIN LARGE ROUND BASE (PLASTIC)		82121	7 PIN SMALL ROUND PLUG (PLASTIC)	
82062	7 PIN LARGE ROUND BASE (METAL)		82141	FLAT 7 PIN PLUG (PLASTIC)	
82161	7 PIN LARGE ROUND PLUG (METAL)		82181	7 PIN LARGE ROUND PLUG (PLASTIC)	
82162	5 PIN LARGE ROUND PLUG (METAL)		82182	5 PIN LARGE ROUND PLUG (PLASTIC)	
5872-10TC	CAB TRAILR 7 CORE 2.5MM 5A 10M				









PART NO.	DESCRIPTION		PART NO.	DESCRIPTION	
81032BL	Cigarette Lighter Plug with Extended Leads & Twin Accessory Sockets - 1mtr (BL Pack)		81026BL	H/Duty Accessory Socket (BL Pack)	 48.5 mm 60W x 45H x 44D (mm)
57810	8 Way Waterproof Junction Box		81130BL	H/Duty Merit Socket (BL Pack)	 48.5 mm 60W x 45H x 44D (mm)
57810	8 Way Weatherproof Junction Box – suit up to 6mm Cable (1 per Pack)	 47 mm 135L x 102W x 38T (mm)	81132BL	H/Duty Engel Type Socket (BL Pack)	 48.5 mm 60W x 45H x 44D (mm)
81025BL	H/Duty Surface Mount Accessory Socket (BL Pack)	 53W x 42H x 79D (mm)	81134BL	H/Duty Dual USB Socket (BL Pack)	 48.5 mm 60W x 45H x 44D (mm)
			81140BL	H/Duty Twin Accessory/Merit Socket (BL Pack)	 86mm 26 mm 105L x 45H x 44D (mm)

PART NO.	DESCRIPTION		PART NO.	DESCRIPTION	
81142BL	H/Duty Twin Merit/Engel Type Socket (BL Pack)	 <p>26 mm 86 mm</p> <p>105L x 45H x 44D(mm)</p>	5812-7BK	Black 2.5mm 5 Amps	
81150BL	H/Duty Surface Mount Merit Socket (BL Pack)	 <p>53W x 42H x 79D(mm)</p>	5812-7GN	Single Core Cable - 7mtrs (Strand NO./di	
81166BL	H/Duty Twin Surface Mount Merit /Engel Type Socket (BL Pack)	 <p>92L x 45H x 83D(mm)</p>	5812-7RD	a.: 8/0.32)	
82109BL	Thermoplasti c Engel Type Plug (BL Pack)		5822-7SP	2mm 2.5 Amps Speaker Cable - 7mtrs & Grey (Strand NO./dia.: 14/0.20)	
82110BL	Combination Cigarette Lighter Plug/Merit Plug (BL Pack)		5823-4F8	3mm 10 Amps Figure 8 Cable - 4mtrs & Red (Strand NO./dia.: 14/0.20)	





PART NO.			DESCRIPTION	PART NO.			DESCRIPTION
5813-7BE	3mm 10 Amps Single Core Cable - 7mtrs (Strand NO./dia.: 14/0.32)	Blue		5814-4BE	4mm 15 Amps Single Core Cable - 4mtrs (Strand NO./dia.: 23/0.32)	Blue	
5813-7BK		Black		5814-4BK		Black	
5813-7BN		Brown		5814-4BN		Brown	
5813-7GN		Green		5814-4GN		Green	
5813-7RD		Red		5814-4RD		Red	
5813-7WE		White		5814-4WE		White	
5813-7YW		Yellow		5814-4YW		Yellow	

PART NO.	DESCRIPTION		PART NO.	DESCRIPTION	
82042BL	7 Pin Flat 'Quickfit' Trailer Socket (BL Pack)		82073BL	12 Pin Flat Trailer Socket with Reed Switch (BL Pack)	
82044BL	7 Pin Flat 'Quickfit' Trailer Socket with Reed Switch (BL Pack)		82141BL	7 Pin Flat 'Quickfit' Trailer Plug (BL pack)	
82052BL	7 Pin Large Round Plastic Trailer Socket (BL Pack)		82161BL	7 Pin Large Round Metal Trailer Plug (BL Pack)	
82062BL	7 Pin Large Round Metal Trailer Socket (BL Pack)		82162BL	5 Pin Large Round Metal Trailer Plug (BL Pack)	
82063BL	5 Pin Large Round Metal Trailer Socket (BL Pack)		82171BL	12 Pin Flat Trailer Plug (BL Pack)	
82072BL	12 Pin Flat Trailer Socket (BL Pack)		82181BL	7 Pin Large Round Plastic Trailer Plug (BL Pack)	

PART NO.	DESCRIPTION		PART NO.	DESCRIPTION	
82185BL	7 Pin Large Round Plastic 'Quickfit' Trailer Plug (BL Pack)		82235BL	7 Pin Large Round Socket on Car to 7 Pin Flat Plug on Trailer (BL Pack)	
82215BL	7 Pin Small Round Socket on Car to 7 Pin Flat Plug on Trailer (BL Pack)		82240BL	5 Pin Large Round Socket on Car to 7 Pin Flat Plug on Trailer (BL Pack)	
82220BL	6 Pin Small Round Socket on Car to 7 Pin Flat Plug on Trailer (BL Pack)		82245BL	7 Pin Flat Socket on Car to 7 Pin Large Round Plug on Trailer (BL Pack)	
82225BL	7 Pin Flat Socket on Car to 7 Pin Small Round Plug on Trailer (BL Pack)		82250BL	7 Pin Flat Socket on Car to 5 Pin Large Round Plug on Trailer (BL Pack)	
82230BL	7 Pin Flat Socket on Car to 6 Pin Small Round Plug on Trailer (BL Pack)		82255BL	7 Pin Large Round Socket on Car to 5 Pin Large Round Plug on Trailer (BL Pack)	

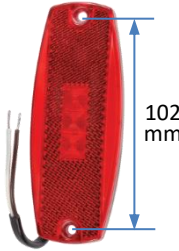

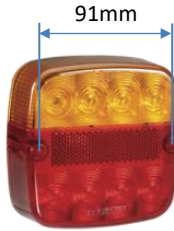

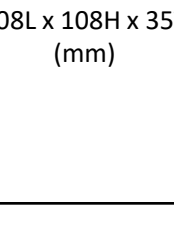
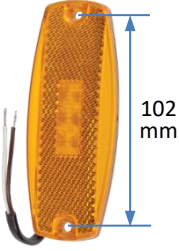
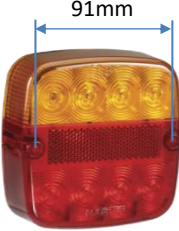

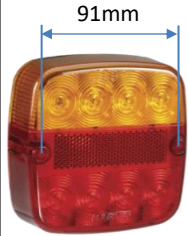
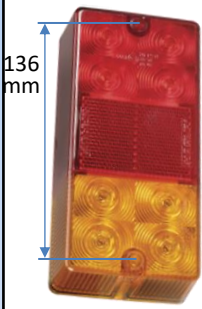
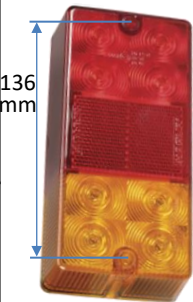
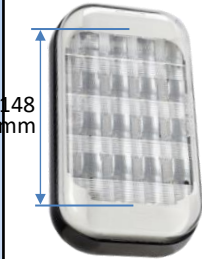
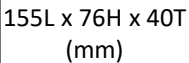
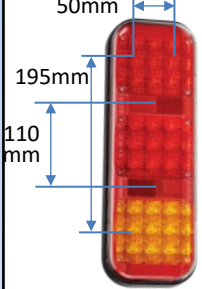
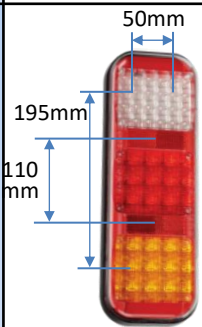

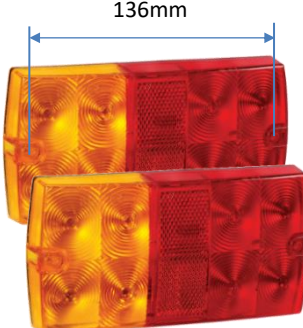
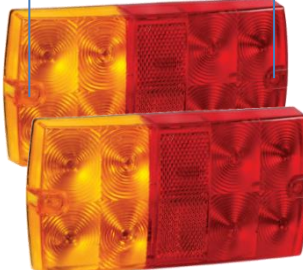
PART NO.	DESCRIPTION		PART NO.	DESCRIPTION	
82260BL	5 Pin Large Round Socket on Car to 7 Pin Large Round Plug on Trailer (BL Pack)		84036BL	Amber Retro Reflector with Self Adhesive (2 per BL Pack)	 70L x 28H(mm)
82265BL	7 Pin Large Round Socket on Car to 7 Pin Small Round Plug on Trailer (BL Pack)		84037BL	Red Retro Reflector with Self Adhesive (2 per BL Pack)	 70L x 28H(mm)
82270BL	7 Pin Large Round Socket on Car to 6 Pin Small Round Plug on Trailer (BL Pack)		84050BL	Clear Retro Reflector with Self Adhesive (2 per BL Pack)	 94L x 44H(mm)
82280BL	6 Pin Small Round Socket on Car to 7 Pin Large Round Plug on Trailer (BL Pack)		84051BL	Amber Retro Reflector with Self Adhesive (2 per BL Pack)	 94L x 44H(mm)
84035BL	Clear Retro Reflector with Self Adhesive (2 per BL Pack)	 70L x 28H(mm)	84052BL	Red Retro Reflector with Self Adhesive (2 per BL Pack)	 94L x 44H(mm)

PART NO.	DESCRIPTION		PART NO.	DESCRIPTION	
85320A	Amber LED Battery Powered Strobe with Magnetic Base (BL Pack)		90862WBL	10-30V LED Licence Plate Lamp in White Housing & 0.5m Cable (BL Pack)	 40mm 97L x 41H (mm)
87508BL	9-33V LED Interior Lamp with Touch Sensitive Switch (BL Pack)	 185L x 150H x 12T (mm)	91402BL	10-33V LED Red/Amber Side Marker Lamp with Black Deflector Base & 0.5m Cable (BL Pack)	 28.5mm 57L x 35H x 21T (mm)
90822CBL	10-30V LED Amber Front End Marker Lamp with Chrome Base & 0.5m Cable (BL Pack)	 72.5mm 110L x 36H x 16T (mm)	91404CBL	10-33V LED Red/Amber Side Marker Lamp with Oval Chrome Base & 0.5m Cable (BL Pack)	 28.5mm 90L x 45H x 26T (mm)
90862BL	10-30V LED Licence Plate Lamp in Charcoal/Black Housing & 0.5m Cable (BL Pack)	 40mm 97L x 41H (mm)	91422BL	10-33V LED Amber Side Marker Lamp with Black Deflector Base & 0.5m Cable (BL Pack)	 28.5mm 57L x 35H x 21T (mm)







PART NO.	DESCRIPTION		PART NO.	DESCRIPTION	
91432BL	10-33V LED Red End Marker Lamp with Black Deflector Base & 0.5m Cable (BL Pack)	 28.5mm 57L x 35H x 21T (mm)	91708BL	9-33V LED Red Side Marker Lamp with In-built Retro Reflector Base & 0.5m Cable (BL Pack)	 102 mm 115L x 44H x 9.5T (mm)
91602BL	9-33V LED Red/Amber Side Marker Lamp with Black Deflector Base & 0.5m Cable (BL Pack)	 50.5mm 28.5mm 74L x 38H x 28T (mm)	93402BL	12V LED Squ. Stop/Tail/Turn Lamp with In-Built Retro Reflector & 0.5m Cable (BL Pack)	 91mm 108L x 108H x 35T (mm)
91622BL	9-33V LED Amber Side Clearance Lamp with Black Deflector Base & 0.5m Cable (BL Pack)	 50.5mm 28.5mm 74L x 38H x 28T (mm)	93404BL	9-30V LED Squ. Stop/Tail/Turn Lamp with In-Built Retro Reflector & 0.5m Cable (BL Pack)	 108L x 108H x 35T (mm)
91700BL	9-33V LED Amber Side Marker Lamp with In-built Retro Reflector Base & 0.5m Cable (BL Pack)	 102 mm 115L x 44H x 9.5T (mm)	93406BL	12V LED Squ. Stop/Tail/Turn & Licence Plate Lamp with In-Built Retro Reflector & 0.5m Cable (BL Pack)	 91mm 108L x 108H x 35T (mm)

PART NO.	DESCRIPTION		PART NO.	DESCRIPTION	
93408BL	9-30V LED Squ. Stop/Tail/Turn & Licence Plate Lamp with In-Built Retro Reflector & 0.5m Cable (BL Pack)	 91mm 108L x 108H x 35T (mm)	93608BL	9-30V LED Rec. Stop/Tail/Turn & Licence Plate Lamp with In-Built Retro Reflector & 0.5m Cable (BL Pack)	 136mm 155L x 76H x 40T (mm)
93602BL	12V LED Rec. Stop/Tail/Turn Lamp with In-Built Retro Reflector & 0.5m Cable (BL Pack)	 136mm	94150HBL	9-33V LED White Reverse Lamp for Horizontal Mounting with 0.5m Cable & Black Case (BL Pack)	 148mm 180L x 100H x 37T (mm)
93604BL	9-30V LED Rec. Stop/Tail/Turn Lamp with In-Built Retro Reflector & 0.5m Cable (BL Pack)	 155L x 76H x 40T (mm)	94202	9-33V LED Twin Stop/Tail/Turn Lamp with In-Built Retro Reflectors & 0.5m Cable (BL Pack)	 50mm 195mm 110mm 284L x 100H x 37T (mm)
			94210	9-33V LED Stop/Tail/Turn & Reverse Lamp with In-Built Retro Reflectors & 0.5m Cable (BL Pack)	 50mm 195mm 110mm 284L x 100H x 37T (mm)

PART NO.	DESCRIPTION	
93440BL2	<p>12V LED Squ. Slimline Trailer Lamp Pack with Licence Plate Lamp & 0.5m Hard-Wired Tinned Cable per Lamp & Stainless Steel Fittings (Twin BL Pack)</p> <ul style="list-style-type: none"> • 1 x 12V LED Squ. Slimline Stop/Tail/Turn Lamp with In-Built Retro Reflector & 0.5m Cable (P/N: 93430) • 1 x 12V LED Squ. Slimline Stop/Tail/Turn & Licence Plate Lamp with In-Built Retro Reflector & 0.5m Cable (P/N: 93434) 	 <p>87mm</p> <p>107L x 107H x 26T (mm)</p>
93640BL2	<p>12V LED Rec. Slimline Trailer Lamp Pack with Licence Plate Lamp & 0.5m Hard-Wired Tinned Cable per Lamp & Stainless Steel Fittings (Twin BL Pack)</p> <ul style="list-style-type: none"> • 1 x 12V LED Rec. Slimline Stop/Tail/Turn Lamp with In-Built Retro Reflector & 0.5m Cable (P/N: 93630) • 1 x 12V LED Rec. Slimline Stop/Tail/Turn & Licence Plate Lamp with In-Built Retro Reflector & 0.5m Cable (P/N: 93634) 	 <p>136mm</p>
93642TP	<p>12V LED Rec. Slimline Submersible Trailer Lamp Pack with Licence Plate Lamp & 9m Hard-Wired Tinned Cable per Lamp (Twin BL Pack)</p> <ul style="list-style-type: none"> • 1 x 12V LED Rec. Slimline Stop/Tail/Turn Lamp with In-Built Retro Reflector & 9m Cable (P/N: 93631) • 1 x 12V LED Rec. Slimline Stop/Tail/Turn & Licence Plate Lamp with In-Built Retro Reflector & 9m Cable (P/N: 93635) 	 <p>156L x 81H x 26T (mm)</p>







PART NO.	DESCRIPTION		PART NO.	DESCRIPTION	
54420BL	4-Way STD ATS Blade Fuse Holder (8 Terminals) (BL Pack)	 80L x 45W x 37H (mm)	81135BL	6-33V DC LED Volt Meter (29mm Diameter Mounting Hole) (BL Pack)	
54422BL	6-Way STD ATS Blade Fuse Holder (12 Terminals) (BL Pack)	 100L x 45W x 37H (mm)	81136BL	12-24V DV LED Amp Meter (29mm Diameter Mounting Hole) (BL Pack)	
81051BL	50A H/Duty 5mtrs Battery Connector Extension Lead (BL Pack)		56404	Cable Tie – 4.8 x 200mm (8") (100 per Pack)	
81067BL	50A H/Duty Adaptor (Battery Clips to Battery Connector) (BL Pack)		56406	Cable Tie – 4.8 x 300mm (8") (100 per Pack)	
81068BL	50A H/Duty Adaptor (8mm Ring Terminals to Battery Connector) (BL Pack)		56430	Cable Tie Bulk Pack (1000 per Pack) (incl.: 100 - 2.5 x 100mm (4") 200 - 3.6 x 140mm (5.1/2") 400 - 4.8 x 200mm (8") 200 - 4.8 x 300mm (12"))	

PART NO.	DESCRIPTION		PART NO.	DESCRIPTION	
56707-3	Corrugated Split Sleeve Tubing (Pack) Tube Size: 7mm Internal Dia.: 7mm Length: 3mtrs		5824-5TW	Twin Sheath Cable (BL Pack) Cable Dia.: 4mm AMPS: 15 Length: 5mtrs	
56710-3	Corrugated Split Sleeve Tubing (Pack) Tube Size: 10mm Internal Dia.: 9.7mm Length: 3mtrs		5824-10TW	Twin Sheath Cable (BL Pack) Cable Dia.: 4mm AMPS: 15 Length: 10mtrs	
56711	Corrugated Split Sleeve Tubing (Pack) Tube Size: 10mm Internal Dia.: 9.7mm Length: 30mtrs		5852-6TC	5 Core Trailer Cable (BL Pack) Cable Dia.: 2.5mm AMPS: 5 Length: 6mtrs	
56712	Corrugated Split Sleeve Tubing (Roll) Tube Size: 10mm Internal Dia.: 9.7mm Length: 125mtrs		5852-10TC	5 Core Trailer Cable (BL Pack) Cable Dia.: 2.5mm AMPS: 5 Length: 10mtrs	
56713-3	Corrugated Split Sleeve Tubing (Pack) Tube Size: 13mm Internal Dia.: 12.6mm Length: 3mtrs		<p>***P.S.: Other Sizes Of Tubings or Cables Are Available on Request.***</p>		

PART NO.	DESCRIPTION		PART NO.	DESCRIPTION	
71740	ULTIMA 215 LED 9-33V Driving Light (1 per Box)	 215W x 112D x 235H (mm)	71300	'Pocket' Rechargeable LED Inspection Light (BL Pack)	
74403	Driving Light Harness to suit ULTIMA 215 LED (BL Pack)		71301	'HP Pocket' Rechargeable LED Inspection Lamp (Boxed)	
72358	9-36V 5 x 3W HP LED Work Lamp – 1050 Lumens & Polycarbonate Lens (BL Pack)	 142L x 45H x 93D (mm)	71345	HP Rechargeable Mini LED Floodlight (Boxed)	 185W x 165H x 55D (mm)
72360	9-36V 4 x 5W HP LED Work Lamp – 2000 Lumens & Polycarbonate Lens (BL Pack)	 75L x 79H x 79D (mm)			

PART NO.	DESCRIPTION	
85010A	12/24 Volt Aeromax Mini LED Light Box (Amber) Flange Base & Amber Lens (Boxed) <ul style="list-style-type: none"> • 8 Selectable Flash Patterns • Polycarbonate Lens • Class 1 Approved 	 <p>200L x 173W x 47H (mm)</p>
85012A	12/24 Volt Aeromax Mini LED Light Box (Amber) Magnetic Base (Boxed) <ul style="list-style-type: none"> • 8 Selectable Flash Patterns • Polycarbonate Lens • Class 1 Approved 	 <p>200L x 173W x 47H (mm)</p>
85254A	12/24 Volt 'Eurotech' Low Profile LED Strobe/Rotator Light (Amber) Flange Base (Boxed) <ul style="list-style-type: none"> • 6 Selectable Flash Patterns • Polycarbonate Lens • Class 1 Approved 	 <p>142φ x 80H (mm)</p>
85260A	12/24 Volt 'Eurotech' LED Strobe/Rotator Light (Amber) Flange Base (Boxed) <ul style="list-style-type: none"> • 6 Selectable Flash Patterns • Polycarbonate Lens • Class 1 Approved 	 <p>142φ x 129H (mm)</p>
85274A	12/24 Volt Hi Optics LED Rotating Beacon (Amber) Magnetic Base (Boxed) <ul style="list-style-type: none"> • Polycarbonate Lens • Class 1 Approved • Cigarette Lighter/Merit Plug 	 <p>200φ x 121φ x 175H (mm)</p>
85658A	12/24 Volt Optimax Rotating Beacon (Amber) Magnetic Base (Boxed) <ul style="list-style-type: none"> • Polycarbonate Lens • Cigarette Lighter/Merit Plug • 12V Globe (P/N: 48320) & 24V Globe (P/N: 48702) Are Included In The Box 	 <p>153φ x 110φ x 180H (mm)</p>







PART NO.	DESCRIPTION	
85660A	12/24V LED BEACON FLANGE (A)	 <p>139mm (height) x 154mm (diameter)</p>
85668A	12/24V LED BEACON MAG MOUNT(A)8	 <p>164mm (height) x 154mm (diameter)</p>
85600A	10-33V LED STROBE FLANGE(A)	 <p>68mm (Height) x 142mm (Diameter)</p>
85606A	10-33V LED STROBE FLANGE(A)6 Selectable	 <p>88mm (Height) x 142mm (Diameter)</p>
85612A	10-33V LED STROBE FLANGE(A)	 <p>130mm (Height) x 142mm (Diameter)</p>









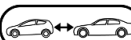



PART NO.	DESCRIPTION	
MX580BL	10-30 Volt LED Side Marker Lamp (Red/Amber) with Black Deflector Base & 400mm Hard Wired Cable (1 per BL Pack) <ul style="list-style-type: none"> • Acrylic Lenses 	 58L x 35H x 25D (mm)
MX581BL	10-30 Volt LED Front End Outline Marker Lamp (White) with Black Deflector Base & 400mm Hard Wired Cable (1 per BL Pack) <ul style="list-style-type: none"> • Acrylic Lenses 	 58L x 35H x 25D (mm)
MX582BL	10-30 Volt LED Side Direction Indicator, Side Marker and Front End Outline Marker Lamp (Amber) with Black Deflector Base & 400mm Hard Wired Cable (1 per BL Pack) <ul style="list-style-type: none"> • Acrylic Lenses 	 58L x 35H x 25D (mm)
MX700BL2	10-30 Volt LED Licence Plate Lamp in Black Housing & 150mm Cable (2 per BL Pack) <ul style="list-style-type: none"> • Acrylic Lenses 	 70L x 26H x 25D (mm)
MX102BL2	12 Volt LED Square Rear Combination Trailer Lamp Kit (Pair per BL Pack) <ul style="list-style-type: none"> • 1 x Squ. Rear Stop/Tail, Direction Indicator Lamp with In-built Retro Reflector & 400mm of Cable • 1 x Squ. Rear Stop/Tail, Direction Indicator with Licence Plate Lamp, In-built Retro Reflector & 400mm of Cable • Acrylic Lenses 	 100L x 100H x 26T (mm)
MX152BL2	12 Volt LED Rectangle Rear Combination Trailer Lamp Kit (Pair per BL Pack) <ul style="list-style-type: none"> • 1 x Rec. Rear Stop/Tail, Direction Indicator Lamp with In-built Retro Reflector & 400mm of Cable • 1 x Rec. Rear Stop/Tail, Direction Indicator with Licence Plate Lamp, In-built Retro Reflector & 400mm of Cable • Acrylic Lenses 	 150L x 80H x 26T (mm)

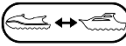



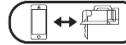

PART NO.	DESCRIPTION
MX160	<p>10-30 Volt LED Rear Combination Lamp (Boxed)</p> <ul style="list-style-type: none"> • 1 x Rec. Rear Stop/Tail/Direction Indicator, Reverse Lamp with In-built Retro Reflector & 400mm of Cable • Acrylic Lenses













283L x 100H x 30D (mm)









Part No.	Description	
AC008	<p>0.8A 12V 4 Stage Battery Charger</p> <ul style="list-style-type: none"> • Input: 100VAC-240VAC, 50-60HZ • Output: 12Volt • Output Current: 0.8A 	
AC015	<p>1.5A 12V 4 Stage Battery Charger</p> <ul style="list-style-type: none"> • Input: 100VAC-240VAC, 50-60HZ • Output: 12Volt • Output Current: 15A 	
AC040	<p>4A 12V 8 Stage Battery Charger</p> <ul style="list-style-type: none"> • Input: 220VAC-240VAC, 50-60HZ • Output: 12V/6V • Output Current: 12V 1, 4A/6V 4A 	
AC080	<p>8A 12V 8 Stage Battery Charger</p> <ul style="list-style-type: none"> • Input: 220VAC-240VAC, 50-60HZ • Output: 12V • Output Current: 2,8A 	
AC250B	<p>12V 2 Stage Automatic Battery Charger</p> <ul style="list-style-type: none"> • Charge & Maintain • Input: 240V, 50Hz, 28W • Output: 1600mA at 12.0V • Unit Size: 123W x 118H x 43T (mm) 	 <div data-bbox="1256 1545 1399 1738"> <p>APPLICATION GUIDE</p>  <p>AUTOMOTIVE BATTERIES (CHARGE)</p>  <p>AUTOMOTIVE BATTERIES (MAINTAIN)</p> </div>

Part No.	Description	
IC1500	INTELLI-CHARGE 12V 15A Battery Charger <ul style="list-style-type: none"> • Input: 240VAC, 50Hz, 240W • Output: 12V • Output Current: 2,4,8, 15A 	
PW350	350W 12V Pure Sine Wave Inverter <ul style="list-style-type: none"> • Input: 12V DC, 30A Max • Output: 240VAC, 50Hz • Output Power: 350W Continuous (700W Peak) 	
PC400	12V 6 Stage Automatic Battery Charger <ul style="list-style-type: none"> • Pro-Charge Range • Input: 240VAC, 50Hz, 132W • Output: 12V • Unit Size: 167W x 104H x 66T (mm) 	 <p>APPLICATION GUIDE</p>  <p>AUTOMOTIVE BATTERIES (inc. CALCIUM)</p>  <p>MARINE BATTERIES</p>  <p>DEEP CYCLE BATTERIES</p>
PC800	12V 6 Stage Automatic Battery Charger <ul style="list-style-type: none"> • Pro-Charge Range • Input: 240VAC, 50Hz, 240W • Output: 12V • Unit Size: 216W x 118H x 66T (mm) 	 <p>APPLICATION GUIDE</p>  <p>AUTOMOTIVE BATTERIES (inc. CALCIUM)</p>  <p>MARINE BATTERIES</p>  <p>DEEP CYCLE BATTERIES</p>
PW600	Pro-Wave Pure Sine Wave Inverter <ul style="list-style-type: none"> • Input: 12V DC, 60A Max • Output: 240VAC, 50Hz • Output Power: 600W Continuous (1200W Peak) • Unit Size: 339W x 190H x 81T (mm) 	 <p>APPLICATION GUIDE</p> 
IDC25	Deep Cycle 9-32V 3 Stage Dual Battery Charger <ul style="list-style-type: none"> • Intelli-Charge DC/Solar • Max. Solar Input: 23Vdc, 385W • Output Current: Input 9-11Vdc 20A, Input 11-32Vdc 25A • Battery Capacity: 75-300Ah • Unit Size: 150L x 122H x 40T (mm) 	

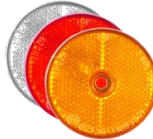
Part No.	Description	
IS1220	<p>12V 1200A Lithium JumpStarter - upto 7.0L P & 4.5L D</p> <ul style="list-style-type: none"> Battery Capacity: 3.0Ah at 12.8V, 12,000mAh at 3.2V Length: Positive 310MM, Negative 270mm 	
IC700	<p>7AMP 12V 7 Stage Auto Battery Charger</p> <ul style="list-style-type: none"> Input: 240VAC, 50Hz, 110W Output: 12V Output Current: 1,2,4,7A Type: 7 Stage Automatic 	
IC2500	<p>25AMP 12V 7 Stage Auto Battery Charger</p> <ul style="list-style-type: none"> Output voltage: 12V Output current: 2, 6, 12, 25A Minimum start voltage: 2.5V Size (mm): 210x81x168 Weight: 1.25 kg 	
BPE330	<p>12V Portable Power Station – 3 Power Outlets</p> <ul style="list-style-type: none"> Battery Box Only suit N70 Size Batteries Material: Polypropylene Internal Size: 330L x 190W x 200H (mm) External Size: 390L x 220W x 280H (mm) 	
IS1500	<p>Intelli-Start 12V Professional Lithium Jumpstarter</p> <ul style="list-style-type: none"> Battery Capacity: 8Ah, 32,000mAh, 102.4wHr Theoretical Short Circuit Current: 1500A Clamp Output: 550A Jumpstarter Leads: 55cmL x 20mm² Weight & Dimensions: 4kg, 235L x 180W x 196H (mm) 	 <div style="text-align: right;"> <p>APPLICATION GUIDE</p>  <p>AUTOMOTIVE BATTERIES</p>  <p>MARINE BATTERIES</p> </div>

PART NO.	DESCRIPTION	
CRL14LHX	12V L/H LED 3 IN 1 LIGHT (NO LICENCE PLATE)	 (100 x 100 x 30)
CRL14RHX	12V R/H LED 3 IN 1 LIGHT c/w LICENCE PLATE	
CRL14VLHB	10-30V L/H LED 3 IN 1 LIGHT (NO LICENCE PLATE)	
CRL14VRHB	10-30V R/H LED 3 IN 1 LIGHT c/w LICENCE PLATE	
CRL108TWB	12V LED 3 IN 1 LIGHT (NO LICENCE PLATE)	 (148 x 76 x 22)
CRL106V	10-33V LED 3 IN 1 LIGHT (NO LICENCE PLATE)	 (150 x 80 x 30)
CRL280R	9-33V LED 3 IN 1 LIGHT c/w REVERSE LIGHT (NO LICENCE PLATE)	 (284 x 100 x 37)
CRL505LEDBL	9-33V LED RECT. STOP/TAILO/TURN JUMBO LIGHT(BL PACK)	

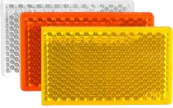
PART NO.	DESCRIPTION	
CRL280	9-33V LED 3 IN 1 LIGHT (NO LICENCE PLATE)	 (284 x 100 x 37)
CRL220	9-33V LED 3 IN 1 LIGHT (NO LICENCE PLATE)	 (222 x 96 x 34)
RM62R	9-33V LED RED REAR MARKER LIGHT	 (57 x 35 x 21)
SM62RA	9-33V LED RED/AMBER SIDE MARKER LIGHT	 (57 x 35 x 21)
SM13RA	9-33V LED RED/AMBER SIDE MARKER LIGHT	 (120 x 64 x 32)
CRL408BL	9-33V LED RECT. RED/AMBER TWIN JUMBO – BLISTER	

Part No.	Description		Part No.	Description	
SM62A	9-33V LED AMBER SIDE MARKER LIGHT	 57x35x21	TR12A	AMBER REFLECTOR (Stick On)	
FM62C	9-33V LED CLEAR FRONT MARKER LIGHT	 57x35x21	TR12C	CLEAR REFLECTOR (Stick On)	 70x20x7.5
RR60A	AMBER REFLECTOR (Bolt On)		TR12R	RED REFLECTOR (Stick On)	
RR60C	CLEAR REFLECTOR (Bolt On)	 60x8	TRB185	6 Ft. TRAILER LIGHT BOARD	 915x139
RR60R	RED REFLECTOR (Bolt On)		TB1500	5 Ft. (LED) TRAILER LIGHT BOARD	 915x139
TR106A	AMBER REFLECTOR (Stick On)		NPL2	9-33V LED LICENCE PLATE LIGHT	 105x48x37.5
TR106C	CLEAR REFLECTOR (Stick On)	 59x31x7.5	NPL7B	9-33V LED LICENCE PLATE LIGHT	 92x50x50
TR106R	RED REFLECTOR (Stick On)				



MARINE PRODUCTS

- BEARING BUDDIES
- BOAT ROLLERS ,
BRACKETS & PINS









136 Port Wakefield Road, CAVAN SA 5094









Ph. 08 8262 7170 Fax. 08 8262 6123

www.satrailer.com.au

PART NO.	DESCRIPTION
B170	STD. BEARING BUDDY
2562	2.1/2" BEARING BUDDY TO SUIT 2 TON HUB
2562-C	2.1/2" BEARING BUDDY COVER
630015	ALKO RED BEARING BUDDY COVER
761197	BLACK BEARING BUDDY COVER



	PART NO.	DESCRIPTION
	R034-150-16	6" PARALLEL POLY ROLLER (16mm BORE) (6" LONG x 3" OUTER DIAMETER)
	R034-150-19	6" PARALLEL POLY ROLLER (19mm BORE) (6" LONG x 3" OUTER DIAMETER)
	R034-300-19	12" PARALLEL POLY ROLLER (19mm BORE) (12" LONG x 3" OUTER DIAMETER)
	R034-300-25	12" PARALLEL POLY ROLLER (25mm BORE) (12" LONG x 3" OUTER DIAMETER)
	0006P	3" COTTON REEL POLY ROLLER (16mm BORE) (3" LONG x 2.3/4" CHAMFER TO 2")
	0100P	4" COTTON REEL POLY ROLLER (16mm BORE) (4" LONG x 2.3/4" CHAMFER TO 2")
	0300P	6" COTTON REEL POLY ROLLER (16mm BORE) (6.1/4" LONG x 2.7/8" CHAMFER TO 2")
	0103P-16	8" COTTON REEL POLY ROLLER (16mm BORE) (7.1/2" LONG x 2.7/8" CHAMFER TO 2")

	PART NO.	DESCRIPTION
	0103P-19	8" COTTON REEL POLY ROLLER (19mm BORE) (7.1/2" LONG x 2.7/8" CHAMFER TO 2")
	0110P	12" COTTON REEL POLY ROLLER (25mm BORE) (11.3/4" LONG x 3.1/4" CHAMFER TO 2")
	R013-170	6" SELF CENTERING POLY ROLLER (16mm BORE) (6.1/2" LONG x 2.1/4" OUTER DIAMETER)
	R013-195	8" SELF CENTERING POLY ROLLER (19mm BORE) (7.3/4" LONG x 2.1/2" OUTER DIAMETER)
	R040	3" POLY GUIDE BALL ROLLER (19mm BORE) (3" x 3")
	R095	POLY WOBBLE ROLLER ONLY (25mm BORE) (4.1/4" LONG x 3.1/2" OUTER DIAMETER)
	V010S	SMALL POLY "V" BLOCK (12mm BORE) (3.1/2" LONG x 3.1/2" DEEP x 2" WIDE)
	V010L	LARGE POLY "V" BLOCK (19mm BORE) (4.1/2" LONG x 4.1/2" DEEP x 3.1/4" WIDE)

PART NO.	DESCRIPTION	PART NO.	DESCRIPTION
761061/071	4.1/2" ROLLER BRACKET & 16mm PIN	761071	4.1/2" x 16mm ROLLER PIN ONLY (OVERALL LENGTH 5.3/4")
761062/072	6" ROLLER BRACKET & 16mm PIN	761072	6" x 16mm ROLLER PIN ONLY (OVERALL LENGTH 8")
761063/079	8" ROLLER BRACKET & 16mm PIN	761079	8" x 16mm ROLLER PIN ONLY (OVERALL LENGTH 9.1/2")
761065/073	8" ROLLER BRACKET & 19mm PIN	761073	8" x 19mm ROLLER PIN ONLY (OVERALL LENGTH 9.1/2")
761064/074	12" ROLLER BRACKET & 25mm PIN	761074	12" x 25mm ROLLER PIN ONLY (OVERALL LENGTH 14.1/4")



4.1/2" BRACKET



6" BRACKET



8" BRACKET



12" BRACKET



4.1/2" x 16mm PIN



6" x 16mm PIN



8" x 16mm PIN



8" x 19mm PIN



12" x 25mm PIN

MOTOR BODY EQUIPMENT

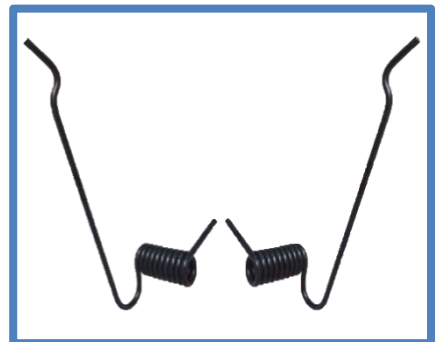







136 Port Wakefield Road, CAVAN SA 5094







Ph. 08 8262 7170 Fax. 08 8262 6123

www.satrailer.com.au

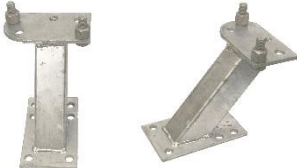
	PART NO.	DESCRIPTION
	9017S	STAINLESS STEEL "T" FLUSH MOUNT LOCK
	22505	FLUSH MOUNT RING LASHES (SMALL)
	9193	FLUSH MOUNT RING LASHES (LARGE)
	10207B	BLACK PUSH BUTTON LOCK (LARGE)
	10207CP	CHROME PUSH BUTTON LOCK (LARGE)
	FU902	ZINC PLATE FLUSH MOUNT LOCK
	FU902SS	STAINLESS STEEL FLUSH MOUNT LOCK



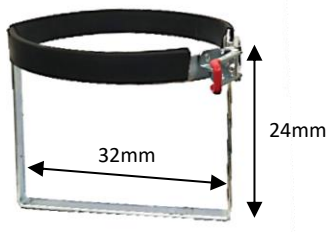
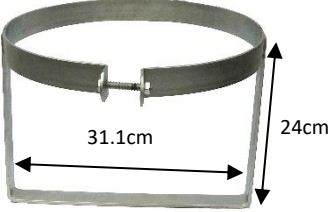
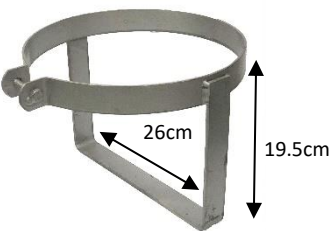
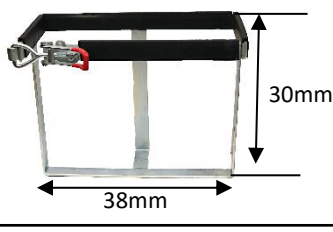
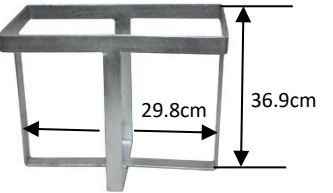

	PART NO.	DESCRIPTION
	ROV4P	SPINNING VENT 4" (PLASTIC) (AVAIL IN METAL)
	8018-400	SCUPPA VENT WHITE (SMALL) (L:16.6cm, W:11.2cm)
	8018-420	SCUPPA VENT WHITE (LARGE) (L:24cm, W:14.5cm)
	CLP00901	CLIPS TO SUIT HOLD DOWN CLAMP
	5202-011	HOLD DOWN CLAMP (LOCKABLE)
	5202-001	HOLD DOWN CLAMP (STANDARD)
	TH016	6" SPRING LOAD TAILGATE CATCH (EACH) (BOLT ON)

	PART NO.	DESCRIPTION
	BR100	SPRING LOADED TAILGATE CATCH (EACH) (WELD ON / BOLT ON)
	EDPM10	RUBBER WASHER TO SUIT DROP LOCKS
	DL	WELD ON DROP LOCKS (PR)
	DLB	BOLT ON DROP LOCKS (PR)
	GR100	GR. TAILGATE CATCH(PR) (WELD ON)
	TGH	TAILGATE HINGES (PR)
	TGHG	GREASEABLE TAILGATE HINGES (PR)

	PART NO.	DESCRIPTION
	1532	SPARE WHEEL CARRIER (GALV) (TO SUIT FORD, HT HOLDEN & TLC(6))
	TIDP	TRAILER ID PLATE
	B5608	RACHET TIE DOWN – 500KG (25mm x 5metre)
	B5609	RACHET TIE DOWN – 1000KG (35mm x 6metre)
	B5601	RACHET TIE DOWN – 2500KG (50mm x 9metre)
	DS10	10mm RATED “D” SHACKLE (1 TON)
	DS11	11mm RATED “D” SHACKLE (1.5 TON)
	DS13	13mm RATED “D” SHACKLE (2 TON)

	PART NO.	DESCRIPTION
	345012-18	18" SINGLE CARAVAN STEP
	SAGBH-ADJ	SAT ADJUSTABLE 9KG GAS BOTTLE HOLDER
	345001-00	EL GAS BOTTLE HOLDER 9 KG
	345001-01	EL GAS BOTTLE HOLDER 4.5 KG
	SAJCH-ADJ	SAT ADJUSTABLE JERRY CAN HOLDER
	SAJCH	SAT JERRY CAN HOLDER

	PART NO.	DESCRIPTION
	<p>92821BK</p>	<p>PACK OF 2 – WHEEL CHOCK – BLACK (200 L X 120 W X 100MM H)</p>
	<p>653000</p>	<p>ALKO STEEL LOADING RAMPS (450 KG)</p>
	<p>CBK3500</p>	<p>WELD ON 3.5T BRACKET & CHAIN KIT (2 – BRACKET + 1 – 13MM X CHAIN)</p>
	<p>TC8-1000</p>	<p>TRAILER SAFETY CHAIN 8MM (1600KG) 1000MM GALV</p>
	<p>TC10-1000</p>	<p>TRAILER SAFETY CHAIN 10MM (2500KG) 1000MM GALV</p>
	<p>TC13-1000</p>	<p>TRAILER SAFETY CHAIN 13MM (3500KG) 1000MM GALV</p>

	PART NO.	DESCRIPTION
	CC8R	8MM HAMMERLOCK CHAIN CONNECTOR 2.0T
	CC10R	10MM SLING HOOK EYE & HAMMERLOCK CONNECTOR KIT 3.15T (PK)
	CC13R	13MM SLING HOOK EYE & HAMMERLOCK CONNECTOR KIT 5.3T (PK)
	MHOOK	MAWBY HOOK 3.5T TRAILER SAFETY CHAIN COUPLING EA
	HWLPK6	HOTWHEEL LABELS (PK OF 6)

PART NO.	DESCRIPTION
HFDS12L	1/2" Horse Float Door Spring Only (Left Side)
HFDS916L	9/16" Horse Float Door Spring Only (Left Side)
HFDS58L	5/8" Horse Float Door Spring Only (Left Side)
HFDS1116L	11/16" Horse Float Door Spring Only (Left Side)
HFDS34L	3/4" Horse Float Door Spring Only (Left Side)
HFDS12R	1/2" Horse Float Door Spring Only (Right Side)
HFDS916R	9/16" Horse Float Door Spring Only (Right Side)
HFDS58R	5/8" Horse Float Door Spring Only (Right Side)
HFDS1116R	11/16" Horse Float Door Spring Only (Right Side)
HFDS34R	3/4" Horse Float Door Spring Only (Right Side)

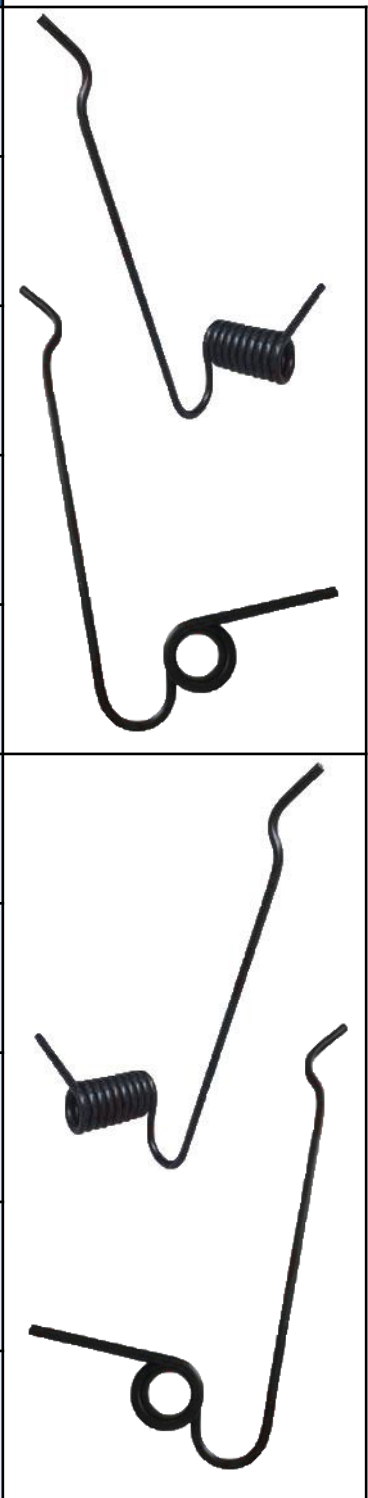

LOAD RATING GUIDE

Calculating Estimated Load in Kg's @ 1 Metre

L = TailGate Length

W = Weight Of Tailgate in Kg's,
 measured @ 90° at furthest point.

'EL' = ESTIMATED LOAD @ 1 Metre in Kg's

$EL = W \times L$

Ex : Tailgate Length = 2.5 Metre's. L = 2.5

Weight at furthest point = 85 Kg's. W = 85

$EL = 2.5 \times 85 = 212.5 \text{ Kg's}$

SELECTING THE CORRECT ASSIST SPRING

Using example above-

EL = 212.5 Kg's (Total Estimated Load)

When using pairs (recommended) divide by half

Each spring needs to carry 106 Kg's Approx. $212.5/2 = 106.25$

HFDS34L/R would be selected here rated 70 Kg's @ 90°, 105 Kg's @ 120°

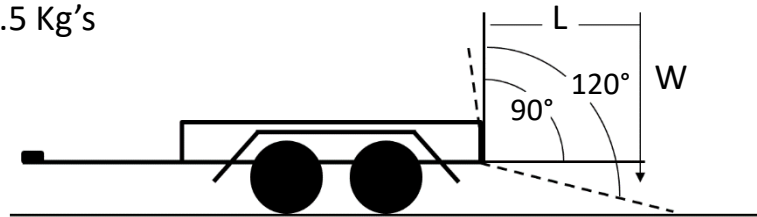

Note: The Tailgate needs to be able to lay stable on the ground. Therefore, 'EL' should NOT exceed the capacity @ 120°

Remember: Tailgate Assist Springs are NOT designed to lift the total weight, rather to ASSIST in the raising and lowering of tailgates.

PART NO.	KG'S SUPPORTED @ 1 METRE @ 90°	KG'S SUPPORTED @ 1 METRE @ 120°
HFDS12L/R	12	17
HFDS916L/R	17	30
HFDS58L/R	30	50
HFDS1116L/R	45	70
HFDS34L/R	70	105



MUDGUARDS & MUDFLAPS

- PLAIN MUDGUARDS
- CHECKER PLATE MUDGUARDS
- PLASTIC MUDGUARDS
- MUDFLAPS TO SUIT PLASTIC MUDGUARDS
- PLAIN MUDFLAPS



136 Port Wakefield Road, CAVAN SA 5094

Ph. 08 8262 7170 Fax. 08 8262 6123

www.satrailer.com.au

PLAIN

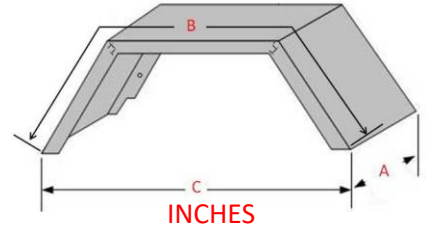
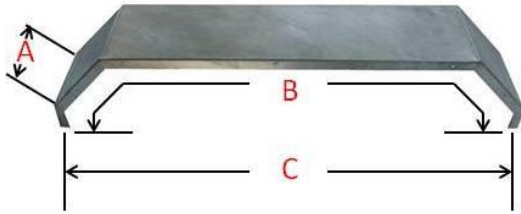

PART NO.	DESCRIPTION	A	B	C
MS2F0742	SINGLE 2-FOLD MINI MUDGUARD SUIT 10" WHEELS	7"	41"	28.5"



PART NO.	DESCRIPTION	A	B	C
MS2F1048	SINGLE 2-FOLD 14" MUDGUARD SUIT 14" & 15" ROAD WHEELS	10"	48"	34.5"



PART NO.	DESCRIPTION	A	B	C
MS4F12LC59	SINGLE 4-FOLD 16" MUDGUARD SUIT 15" & 16" OFF-ROAD WHEELS	12"	62.5"	38"



PART NO.	DESCRIPTION	A	B	C
MT2F1084	TANDEM 2-FOLD 14" MUDGUARD SUIT 14" TANDEM SLIPPER SPRINGS	10"	84"	69.25"



PART NO.	DESCRIPTION	A	B	C
MT4F1084	TANDEM 4-FOLD 14" MUDGUARD SUIT 14" TANDEM SLIPPER SPRINGS	10"	84"	61.5"



PART NO.	DESCRIPTION	A	B	C
MT4F1096	TANDEM 4-FOLD 14" MUDGUARD SUIT 14" TANDEM ROLLER ROCKER	10"	96"	71"



PART NO.	DESCRIPTION	A	B	C
MT4F1296	TANDEM 4-FOLD 16" MUDGUARD SUIT 16" TANDEM ROLLER ROCKER	12"	96"	72"



PART NO.	DESCRIPTION	A	B	C
MS2F1048G	SINGLE GALV 2-FOLD 14" MUDGUARD SUIT 14" & 15" ROAD WHEELS	10"	48"	35"



PART NO.	DESCRIPTION	A	B	C
MT2F1084G	TANDEM GALV 2-FOLD 14" MUDGUARD SUIT 14" TANDEM SLIPPER SPRINGS	10"	84"	69.75"

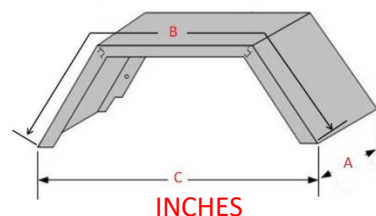
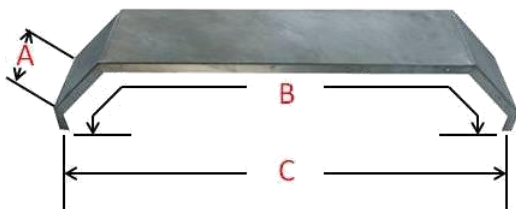

INCHES



PART NO.	DESCRIPTION	A	B	C
MSCP4F9	SINGLE C/P 4-FOLD 14" MUDGUARD SUIT 14" ROAD WHEELS	9"	48"	33.75"



PART NO.	DESCRIPTION	A	B	C
MSCP4F11	SINGLE C/P 4-FOLD 16" MUDGUARD SUIT 15" & 16" OFF-ROAD WHEELS	11"	62.5"	39"



PART NO.	DESCRIPTION	A	B	C
MTCP4F984	TANDEM C/P 4-FOLD 14" MUDGUARD SUIT 14" TANDEM SLIPPER SPRINGS	9"	84"	60.75"



PART NO.	DESCRIPTION	A	B	C
MTCP4F991	TANDEM C/P 4-FOLD 14" MUDGUARD SUIT 14" TANDEM ROCKER	9"	91"	68.5"



PART NO.	DESCRIPTION	A	B	C
MTCP4F996	TANDEM C/P 4-FOLD 14" MUDGUARD SUIT 14" TANDEM ROLLER ROCKER	9"	96"	73"



PART NO.	DESCRIPTION	A	B	C
MTCP4F1191	TANDEM C/P 4-FOLD 16" MUDGUARD SUIT 16" TANDEM ROCKER	11"	91"	68.7 "



PART NO.	DESCRIPTION	A	B	C
MTCP4F1196	TANDEM C/P 4-FOLD 16" MUDGUARD SUIT 16" TANDEM ROLLER ROCKER	11"	95.75"	72.75"

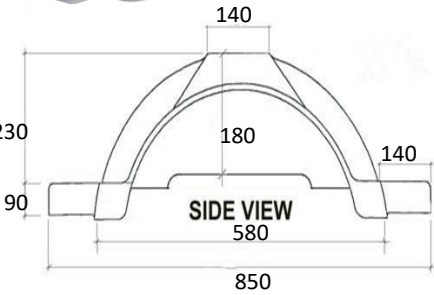

10" PLASTIC MUDGUARDS

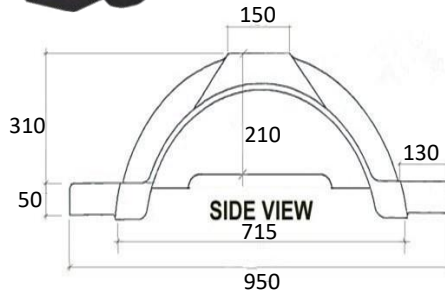

13" PLASTIC MUDGUARDS

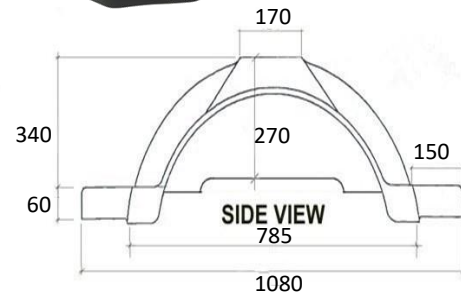

14" PLASTIC MUDGUARDS

PART NO.	DESCRIPTION	COLOUR
PMG10B PMG10S PMG10W	PAIR 10" PLASTIC MUDGUARDS	BLACK SILVER WHITE
PMG13B PMG13S PMG13W	PAIR 13" PLASTIC MUDGUARDS	BLACK SILVER WHITE
PMG14B PMG14S PMG14W	PAIR 14" PLASTIC MUDGUARDS	BLACK SILVER WHITE



PART NO.	DESCRIPTION
PMGBRAC	BRACKETS to suit PLASTIC MUDGUARDS

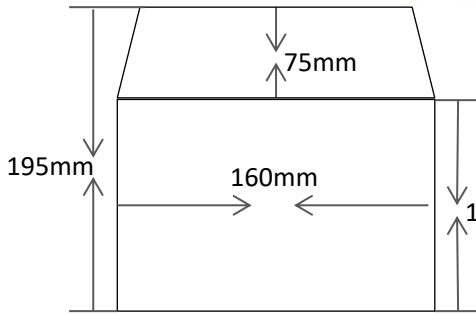

MUDFLAP SUIT PLASTIC MUDGUARDS 10"

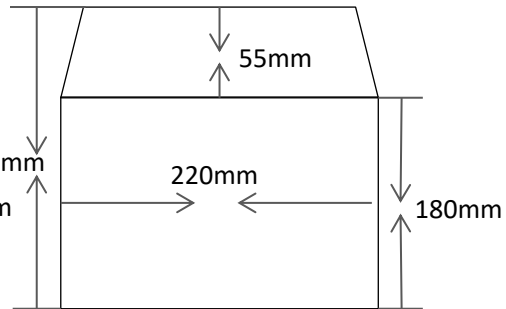

MUDFLAP SUIT PLASTIC MUDGUARDS 13" & 14"

DESCRIPTION	COLOUR
<p>MUDFLAP SUIT PLASTIC MUDGUARDS 10"</p>	<p>BLACK SILVER WHITE</p>
<p>MUDFLAP SUIT PLASTIC MUDGUARDS 13" & 14"</p>	<p>BLACK SILVER WHITE</p>

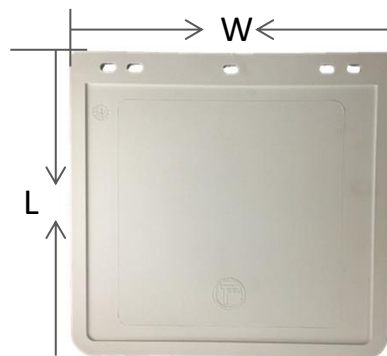
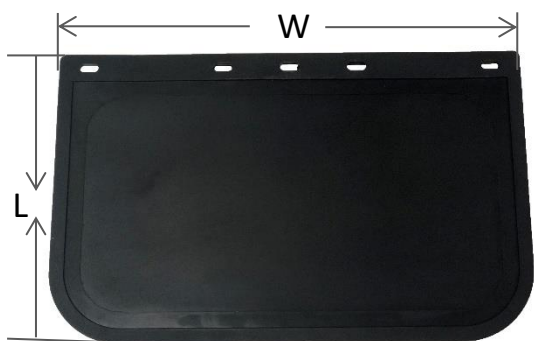





PART NO.	DESCRIPTION	COLOUR
MF82510B MF82510W	8.25"(W) x 10"(L) PLAIN MUDFLAP	BLACK WHITE
MF910B MF910W	9"(W) x 10"(L) PLAIN MUDFLAP	BLACK WHITE
MF912B MF912W	9"(W) x 12"(L) PLAIN MUDFLAP	BLACK WHITE
MF914B MF914W	9"(W) x 14"(L) PLAIN MUDFLAP	BLACK WHITE
MF1111B MF1111W	11"(W) x 11"(L) PLAIN MUDFLAP	BLACK WHITE
MF1114B MF1114W	11"(W) x 14"(L) PLAIN MUDFLAP	BLACK WHITE
MF1812B MF1812W	18"(W) x 12"(L) PLAIN MUDFLAP	BLACK WHITE
MF2214B MF2214W	22"(W) x 14"(L) PLAIN MUDFLAP	BLACK WHITE

GREASE , PAINT & LUBRICANT



136 Port Wakefield Road, CAVAN SA 5094
Ph. 08 8262 7170 Fax. 08 8262 6123
www.satrailer.com.au

PART NO.	DESCRIPTION	
H520401-77	MOBIL HYDRAULIC BRAKE FLUID X 500 ML	
H520401-78	MOBIL HYDRAULIC BRAKE FLUID X 4 LTRS	
EPC3450	MOBIL 450G EP C3 GREASE	
581201-65	MOBIL GREASE XHP 222 450G W.P. GREASE	
581201-64	MOBIL GREASE XHP 222 WATERPROOF GREASE 2.5KG	
71-020202-30	MOBIL GREASE XHP 222 WATERPROOF GREASE 20KG	
EC320	MOBILUX EP 3 GREASE 20KG	

PART NO.	DESCRIPTION	
30	<p>400 GRAM MULTI-PURPOSE CAN 5.56 CRC SPRAY</p> <ul style="list-style-type: none"> • Penetrant • Lubricant • Water dispersant • Rust preventative 	
42034002	<p>DY-MARK MULTI-PURPOSE LUBRICANT 400G</p> <ul style="list-style-type: none"> • Penetrant & Lubricant • Rust Preventative • Displaces Moisture 	
CG400	<p>COLD GALVINISING SPRAY 400G</p> <ul style="list-style-type: none"> • Quick Dry • Long Lasting Metal Protection • Excellent Adhesion Properties • Provides A Tough And Durable Finish To Metal Surfaces 	
42034002	<p>MOTORTECH HEAVY DUTY DEGREASER 400G</p> <ul style="list-style-type: none"> • Heavy Duty trade quality degreaser • Degreases engine & transmission parts on all vehicles • Removes oil & other deposits from concrete paths & all other masonry surfaces • Degreases tractors and trailer parts, stationary machinery, mowers, forklifts & cranes • Cleans chain saws & all tools 	

SPRINGS & SPARE PARTS

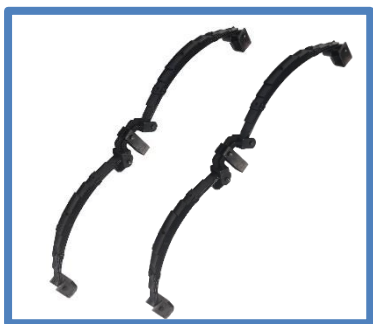
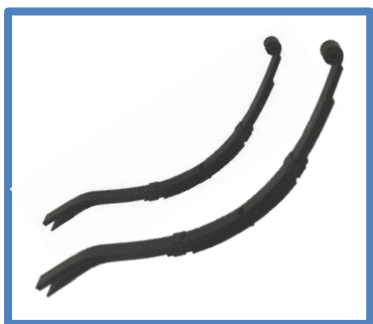

- EYE TO EYE SPRINGS
- OUTBACK SPRINGS
- PARABOLIC SPRINGS
- SLIPPER SPRING
- TANDEM ROCKER SPRINGS
- TANDEM ROCKER ROLLER SPRINGS
- SPRINGS SPARE PARTS



136 Port Wakefield Road, CAVAN SA 5094

Ph. 08 8262 7170 Fax. 08 8262 6123

www.satrailer.com.au

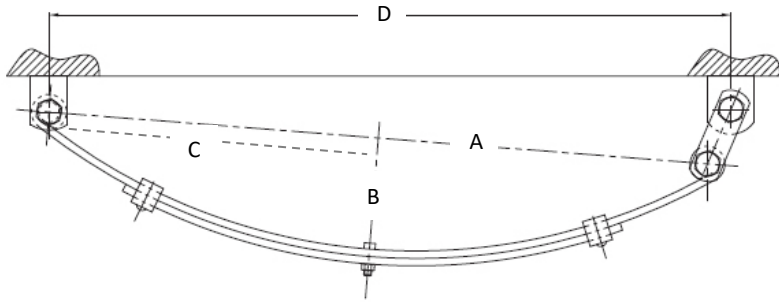

HANGER KIT



SPRINGS

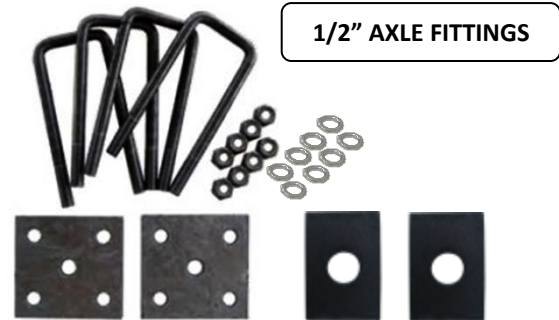

1/2" AXLE FITTINGS

45MM x 8MM EYE to EYE SPRING SETS

PART NO.	DESCRIPTION	CARRYING CAPACITY	FINISH	A	B	C	D
SE456S	SET AK. 6L x 45mm x 8mm EYE to EYE SPRINGS	1500KG	BLACK	711mm	120mm	355mm	735mm
SE458S	SET AK. 8L x 45mm x 8mm EYE to EYE SPRINGS	1900KG	BLACK	711mm	120mm	355mm	735mm

PLEASE NOTE: SET OF SPRINGS INC. SPRINGS, HANGER KIT & 1/2" AXLE FITTINGS

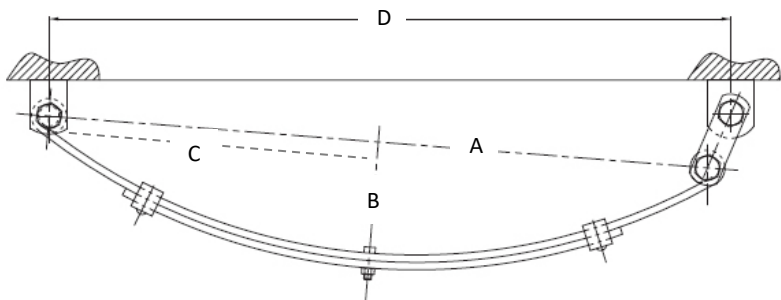

HANGER KIT

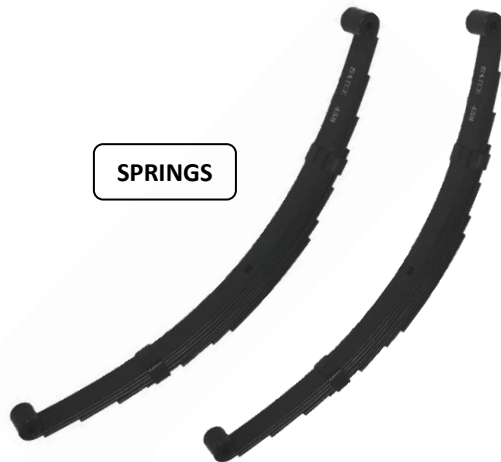

SPRINGS



1/2" AXLE FITTINGS

45MM EYE TO EYE SPRING SETS

PART NO.	DESCRIPTION	CARRYING CAPACITY	FINISH	A	B	C	D
SASE456S	SET SAT 6L x 45mm EYE to EYE SPRINGS	750KG	BLACK	716mm	145mm	367mm	722mm
SASE458S	SET SAT 8L x 45mm EYE to EYE SPRINGS	950KG					
SASE4510S	SET SAT 10L x 45mm EYE to EYE SPRINGS	1270KG					

PLEASE NOTE: SET OF SPRINGS INC. SPRINGS, HANGER KIT & 1/2" AXLE FITTINGS

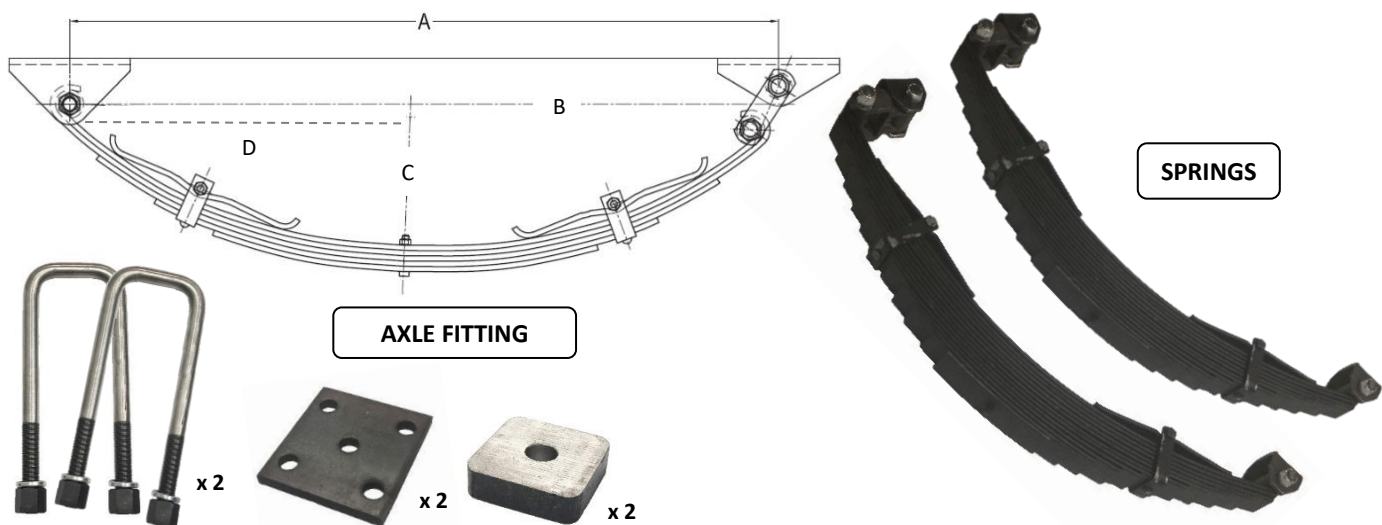

60MM x 8MM EYE TO EYE SPRING SETS

PART NO.	DESCRIPTION	CARRYING CAPACITY	FINISH	A(MM)	B(MM)	C(MM)	D(MM)
SM6013EES	SET MT. 13L x 60mm x 8mm EYE TO EYE SPRING	3000KG	BLACK	900	470	130	465

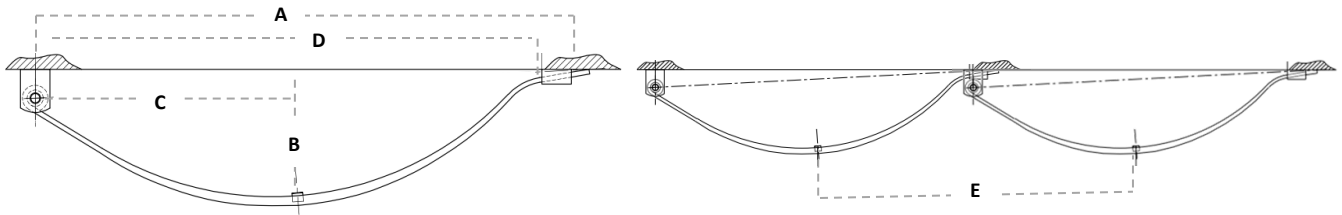

HANGER KIT



1/2" AXLE FITTINGS

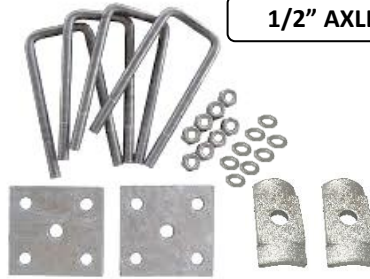

SPRINGS

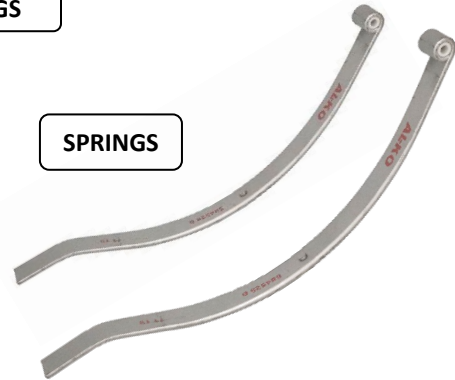

45MM DACROMET PARABOLIC SPRING SETS

PART NO.	DESCRIPTION	CARRYING CAPACITY	SPRING BUSH DIMENSIONS	A(mm)	B(mm)	C(mm)	D(mm)	E(mm)
SPBS600G	SET AK. 45mm x 13mm PARABOLIC SPRING	600KG	1/2" x 7/8" x 45mm	755	150	350	690	710
SPBS1000G	SET AK. 45mm x 15mm PARABOLIC SPRING	1000KG						
SPBS1400G	SET AK. 45mm x 18mm PARABOLIC SPRING	1400KG						

PLEASE NOTE: SET OF SPRINGS INC. SPRINGS, HANGER KIT & 1/2" AXLE FITTINGS

45MM DACROMET PARABOLIC SPRING ONLY

PART NO.	DESCRIPTION	CARRYING CAPACITY	SPRING BUSH DIMENSIONS	A(mm)	B(mm)	C(mm)	D(mm)	E mm)
SPB600G	AK. 45mm x 13mm PARABOLIC SPRING ONLY	300KG	1/2" x 7/8" x 45mm	755	150	350	690	710
SPB1000G	AK. 45mm x 15mm PARABOLIC SPRING ONLY	500KG						
SPB1400G	AK. 45mm x 18mm PARABOLIC SPRING ONLY	700KG						

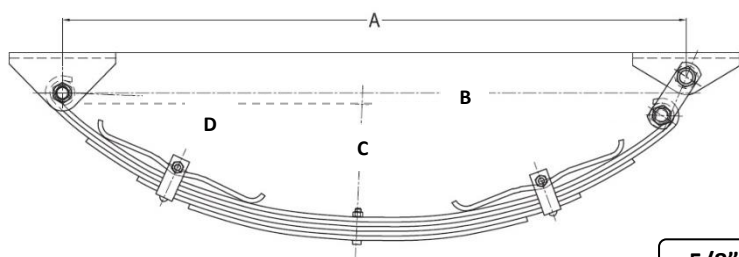

HANGER KIT

5/8" AXLE FITTINGS

SPRINGS



60MM BLACK OUTBACK SPRING SETS

PART NO.	DESCRIPTION	CARRYING CAPACITY	SINGLE AXLE SET UP DIMENSION "A" (NO LOAD)	B(mm)	C(mm)	D(mm)
SOB5S	SET AK. 5L x 60mm x 7mm EYE TO EYE OUTBACK SPRING	1150KG	865/875mm	841mm	158mm	420mm
SOB6S	SET AK. 6L x 60mm x 7mm EYE TO EYE OUTBACK SPRING	1350KG	865/875mm	841mm	158mm	420mm
SOB7S	SET AK. 7L x 60mm x 7mm EYE TO EYE OUTBACK SPRING	1550KG	865/875mm	841mm	158mm	420mm
SOB8S	SET AK. 8L x 60mm x 7mm EYE TO EYE OUTBACK SPRING	1750KG	865/875mm	841mm	158mm	420mm
SOB9S	SET AK. 9L x 60mm x 7mm EYE TO EYE OUTBACK SPRING	2000KG	865/875mm	841mm	158mm	420mm
SOB10S	SET AK. 10L x 60mm x 7mm EYE TO EYE OUTBACK SPRING	2500KG	865/875mm	841mm	158mm	420mm

PLEASE NOTE: SET OF SPRINGS INC. SPRINGS, HANGER KIT & 5/8" AXLE FITTINGS

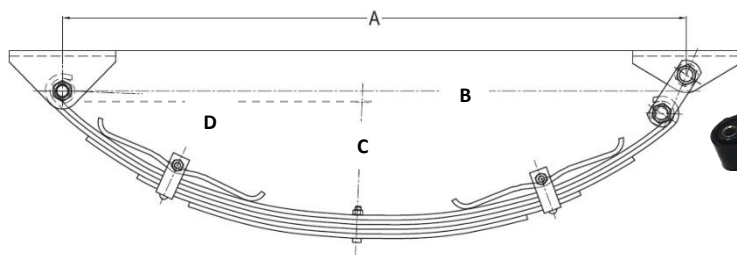

60MM BLACK OUTBACK SINGLE SPRING c/w HANGER KIT

PART NO.	DESCRIPTION	CARRYING CAPACITY	SINGLE AXLE SET UP DIMENSION "A" (NO LOAD)	B(mm)	C(mm)	D(mm)
SOB5	AK. 5L x 60mm x 7mm EYE TO EYE OUTBACK SPRING c/w HANGER KIT	575KG	865/875mm	841mm	158mm	420mm
SOB6	AK. 6L x 60mm x 7mm EYE TO EYE OUTBACK SPRING c/w HANGER KIT	675KG	865/875mm	841mm	158mm	420mm
SOB7	AK. 7L x 60mm x 7mm EYE TO EYE OUTBACK SPRING c/w HANGER KIT	775KG	865/875mm	841mm	158mm	420mm
SOB8	AK. 8L x 60mm x 7mm EYE TO EYE OUTBACK SPRING c/w HANGER KIT	875KG	865/875mm	841mm	158mm	420mm
SOB9	AK. 9L x 60mm x 7mm EYE TO EYE OUTBACK SPRING c/w HANGER KIT	1000KG	865/875mm	841mm	158mm	420mm
SOB10	AK. 10L x 60mm x 7mm EYE TO EYE OUTBACK SPRING c/w HANGER KIT	1250KG	865/875mm	841mm	158mm	420mm

PLEASE NOTE: SINGLE SPRING c/w HANGER KIT (NO AXLE FITTINGS)

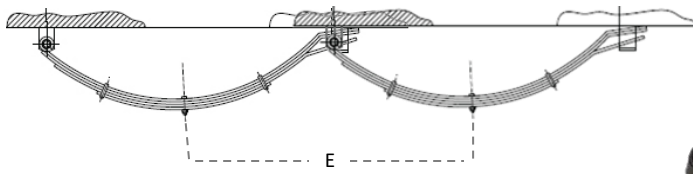
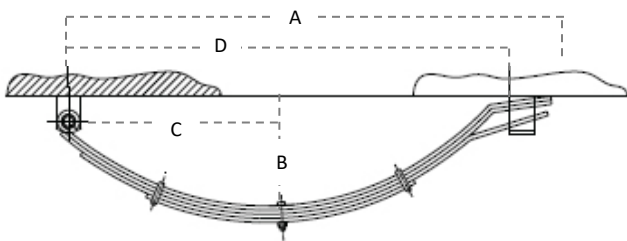

HANGER KIT

1/2" AXLE FITTINGS

SPRINGS

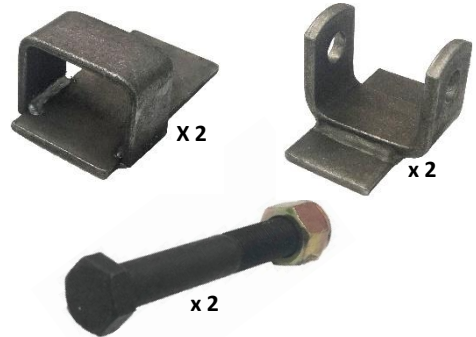

60MM x 6MM BLACK SLIPPER SPRING SETS

PART NO.	DESCRIPTION	CARRYING CAPACITY	SPRING BUSH DIMENSIONS	A(mm)	B(mm)	C(mm)	D(mm)	E(mm)
SS606S	SET AK. 6L x 60mm x 6mm SLIPPER SPRING *	1300KG	5/8" x 7/8" x 60mm	765	150	330	700	730
SS607S	SET AK. 7L x 60mm x 6mm SLIPPER SPRING *	1400KG						
SS609S	SET AK. 9L x 60mm x 6mm SLIPPER SPRING 🌿	1700KG						

PLEASE NOTE: SET OF SPRINGS INC. SPRINGS, HANGER KIT & 1/2" AXLE FITTINGS

🌿 PLEASE NOTE: SET OF 9L SLIPPER SPRING c/w HANGER KIT & 5/8" AXLE FITTINGS 🌿

60MM x 6MM BLACK SLIPPER SPRING ONLY

PART NO.	DESCRIPTION	CARRYING CAPACITY	SPRING BUSH DIMENSIONS	A(mm)	B(mm)	C(mm)	D(mm)	E(mm)
SS606	AK. 6L x 60mm x 6mm SLIPPER SPRING ONLY	650KG	5/8" x 7/8" x 60mm	765	150	330	700	730
SS607	AK. 7L x 60mm x 6mm SLIPPER SPRING ONLY	700KG						
SS609	AK. 9L x 60mm x 6mm SLIPPER SPRING ONLY	850KG						

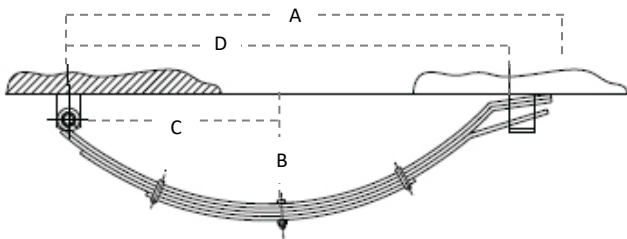

HANGER KIT

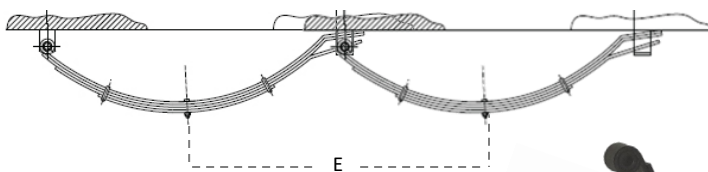

1/2" AXLE FITTINGS



SPRINGS

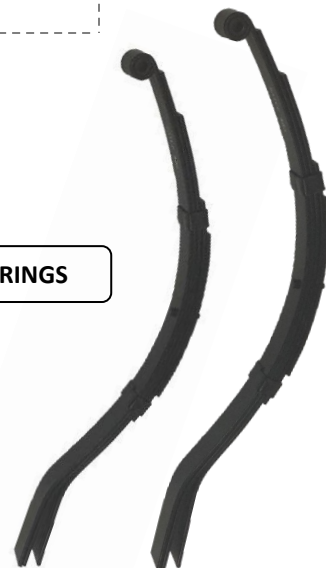

45MM BLACK SLIPPER SPRING SETS

PART NO.	DESCRIPTION	SPRING BUSH DIMENSIONS	CARRYING CAPACITY	A(mm)	B(mm)	C(mm)	D(mm)	E(mm)
SASS453S	SET SAT 3L x 45mm SLIPPER SPRING	7/8" x 1/2" x 45mm	500KG	765	155	330	700	725
SASS454S	SET SAT 4L x 45mm SLIPPER SPRING		700KG					
SASS455S	SET SAT 5L x 45mm SLIPPER SPRING		1000KG					
SASS456S	SET SAT 6L x 45mm SLIPPER SPRING		1120KG					
SASS457S	SET SAT 7L x 45mm SLIPPER SPRING		1270KG					
SASS458S	SET SAT 8L x 45mm SLIPPER SPRING		1375KG					
SASS459S	SET SAT 9L x 45mm SLIPPER SPRING		1500KG					

PLEASE NOTE: SET OF SPRINGS INC. SPRINGS, HANGER KIT & 1/2" AXLE FITTINGS

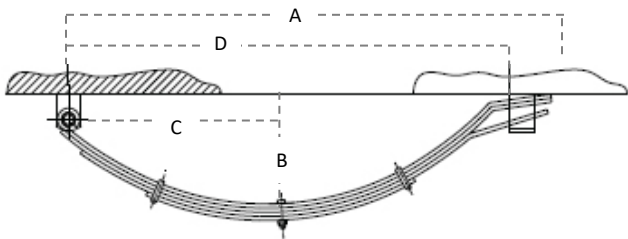

45MM BLACK SLIPPER SPRING ONLY

PART NO.	DESCRIPTION	SPRING BUSH DIMENSIONS	CARRYING CAPACITY	A(mm)	B(mm)	C(mm)	D(mm)
SASS453	SET SAT 3L x 45mm SLIPPER SPRING ONLY	7/8" x 1/2" x 45mm	250KG	765	155	330	700
SASS454	SET SAT 4L x 45mm SLIPPER SPRING		350KG				
SASS455	SET SAT 5L x 45mm SLIPPER SPRING ONLY		500KG				
SASS456	SET SAT 6L x 45mm SLIPPER SPRING ONLY		560KG				
SASS457	SET SAT 7L x 45mm SLIPPER SPRING ONLY		635KG				
SASS458	SET SAT 8L x 45mm SLIPPER SPRING ONLY		688KG				
SASS459	SET SAT 9L x 45mm SLIPPER SPRING ONLY		750KG				

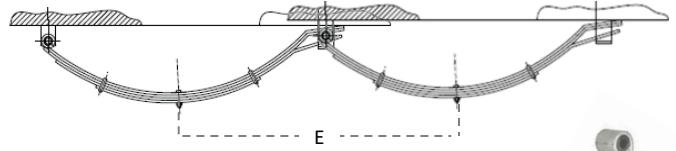
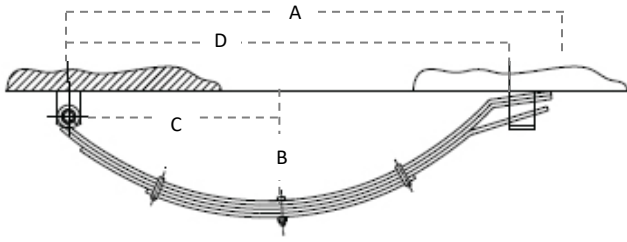

GALV HANGER KIT

GALV 1/2" AXLE FITTINGS

SPRINGS



45MM DACROMET SLIPPER SPRING SETS

PART NO.	DESCRIPTION	SPRING BUSH DIMENSIONS	CARRYING CAPACITY	A(mm)	B(mm)	C(mm)	D(mm)	E(mm)
SASS453SG	SET SAT 3L x 45mm DAC SLIPPER SPRING	7/8" x 1/2" x 45mm	500KG	765	155	330	700	725
SASS454SG	SET SAT 4L x 45mm DAC SLIPPER SPRING		700KG					
SASS455SG	SET SAT 5L x 45mm DAC SLIPPER SPRING		1000KG					
SASS456SG	SET SAT 6L x 45mm DAC SLIPPER SPRING		1120KG					
SASS457SG	SET SAT 7L x 45mm DAC SLIPPER SPRING		1270KG					
SASS459SG	SET SAT 9L x 45mm DAC SLIPPER SPRING		1500KG					

PLEASE NOTE: SET OF SPRINGS INC. SPRINGS, GALV HANGER KIT & GALV 1/2" AXLE FITTINGS

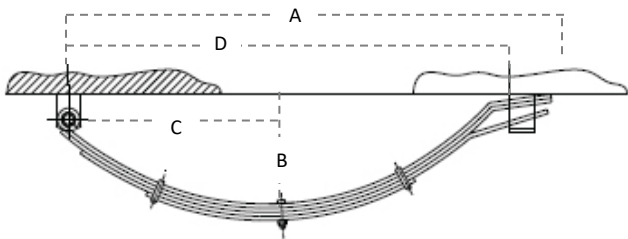

45MM DACROMET SLIPPER SPRING ONLY

PART NO.	DESCRIPTION	SPRING BUSH DIMENSIONS	CARRYING CAPACITY	A(mm)	B(mm)	C(mm)	D(mm)
SASS453G	SET SAT 3L x 45mm DAC SLIPPER SPRING ONLY	7/8" x 1/2" x 45mm	500KG	765	155	330	700
SASS454G	SET SAT 4L x 45mm DAC SLIPPER SPRING ONLY		700KG				
SASS455G	SET SAT 5L x 45mm DAC SLIPPER SPRING ONLY		1000KG				
SASS456G	SET SAT 6L x 45mm DAC SLIPPER SPRING ONLY		1120KG				
SASS457G	SET SAT 7L x 45mm DAC SLIPPER SPRING ONLY		1270KG				
SASS459G	SET SAT 9L x 45mm DAC SLIPPER SPRING ONLY		1500KG				

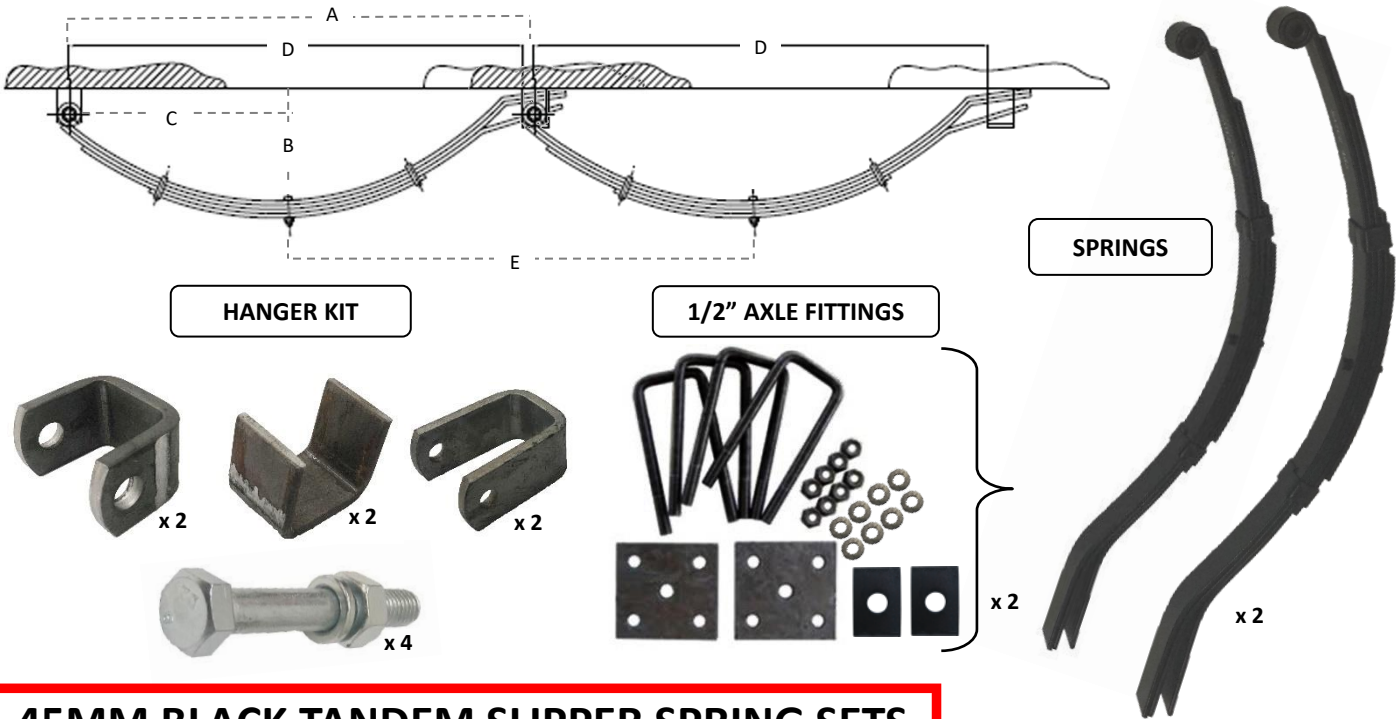

45MM BLACK TANDEM SLIPPER SPRING SETS

PART NO.	DESCRIPTION	SPRING BUSH DIMENSIONS	CARRYING CAPACITY	A(mm)	B(mm)	C(mm)	D(mm)	E(mm)
SASST453S	SET SAT 3L x 45mm TANDEM SLIPPER SPRING	7/8" x 1/2" x 45mm	1000KG	765	155	330	700	707
SASST454S	SET SAT 4L x 45mm TANDEM SLIPPER SPRING		1400KG					
SASST455S	SET SAT 5L x 45mm TANDEM SLIPPER SPRING		2000KG					
SASST456S	SET SAT 6L x 45mm TANDEM SLIPPER SPRING		2240KG					
SASST457S	SET SAT 7L x 45mm TANDEM SLIPPER SPRING		2540KG					
SASST458S	SET SAT 8L x 45mm TANDEM SLIPPER SPRING		2750KG					
SASST459S	SET SAT 9L x 45mm TANDEM SLIPPER SPRING		3000KG					

PLEASE NOTE: SET OF SPRINGS INC. SPRINGS, HANGER KIT & 1/2" AXLE FITTINGS

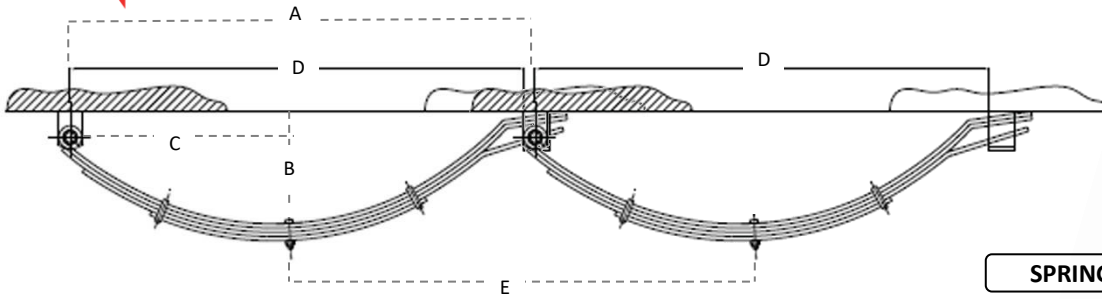

GALV HANGER KIT

GALV 1/2" AXLE FITTINGS

SPRINGS

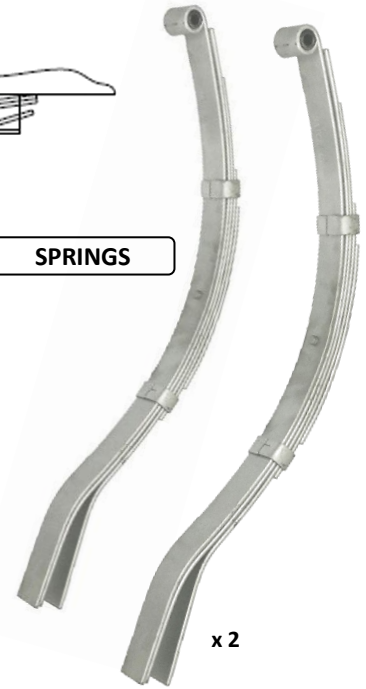
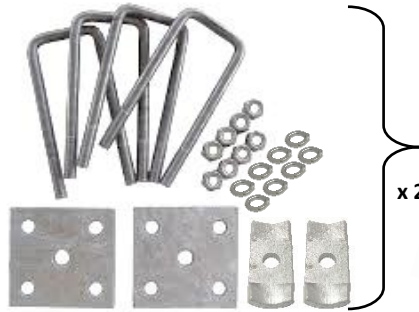
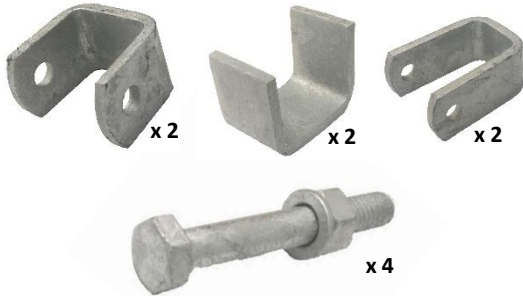

45MM DACROMET TANDEM SLIPPER SPRING SETS

PART NO.	DESCRIPTION	SPRING BUSH DIMENSIONS	CARRYING CAPACITY	A(mm)	B(mm)	C(mm)	D(mm)	E(mm)
SASST453SG	SET SAT 3L x 45mm DAC TANDEM SLIPPER SPRING	7/8" x 1/2" x 45mm	1000KG	765	155	330	700	707
SASST454SG	SET SAT 4L x 45mm DAC TANDEM SLIPPER SPRING		1400KG					
SASST455SG	SET SAT 5L x 45mm DAC TANDEM SLIPPER SPRING		2000KG					
SASST456SG	SET SAT 6L x 45mm DAC TANDEM SLIPPER SPRING		2240KG					
SASST457SG	SET SAT 7L x 45mm DAC TANDEM SLIPPER SPRING		2540KG					
SASST459SG	SET SAT 9L x 45mm DAC TANDEM SLIPPER SPRING		3000KG					

PLEASE NOTE: SET OF SPRINGS INC. SPRINGS, GALV HANGER KIT & GALV 1/2" AXLE FITTINGS

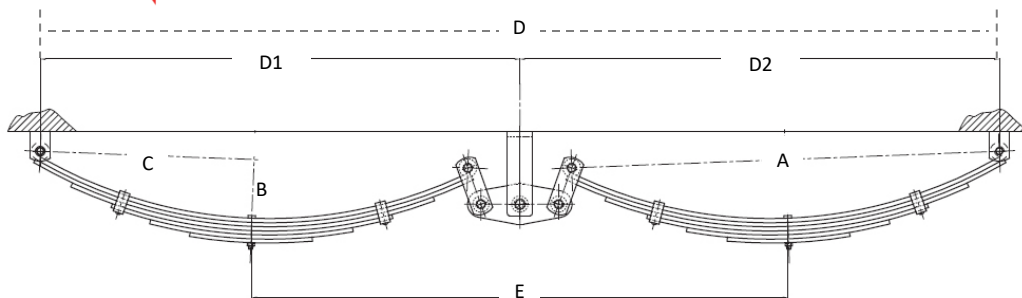

HANGER KIT

1/2" AXLE FITTING



60MM x 6MM BLACK TANDEM ROCKER SPRING SETS

PART NO.	DESCRIPTION	CARRYING CAPACITY	A(mm)	B(mm)	C(mm)	D(mm)	D1=D2 (mm)	E(mm)
SR605-14S	SET AK. 5L x 60mm x 6mm TANDEM ROCKER SPRING	2000KG	700	120	386	1650	825	893
SR606-14S	SET AK. 6L x 60mm x 6mm TANDEM ROCKER SPRING	3000KG						
SR607-14S	SET AK. 7L x 60mm x 6mm TANDEM ROCKER SPRING	3400KG						

PLEASE NOTE: SET OF SPRINGS INC. SPRINGS, HANGER KIT & 1/2" AXLE FITTINGS

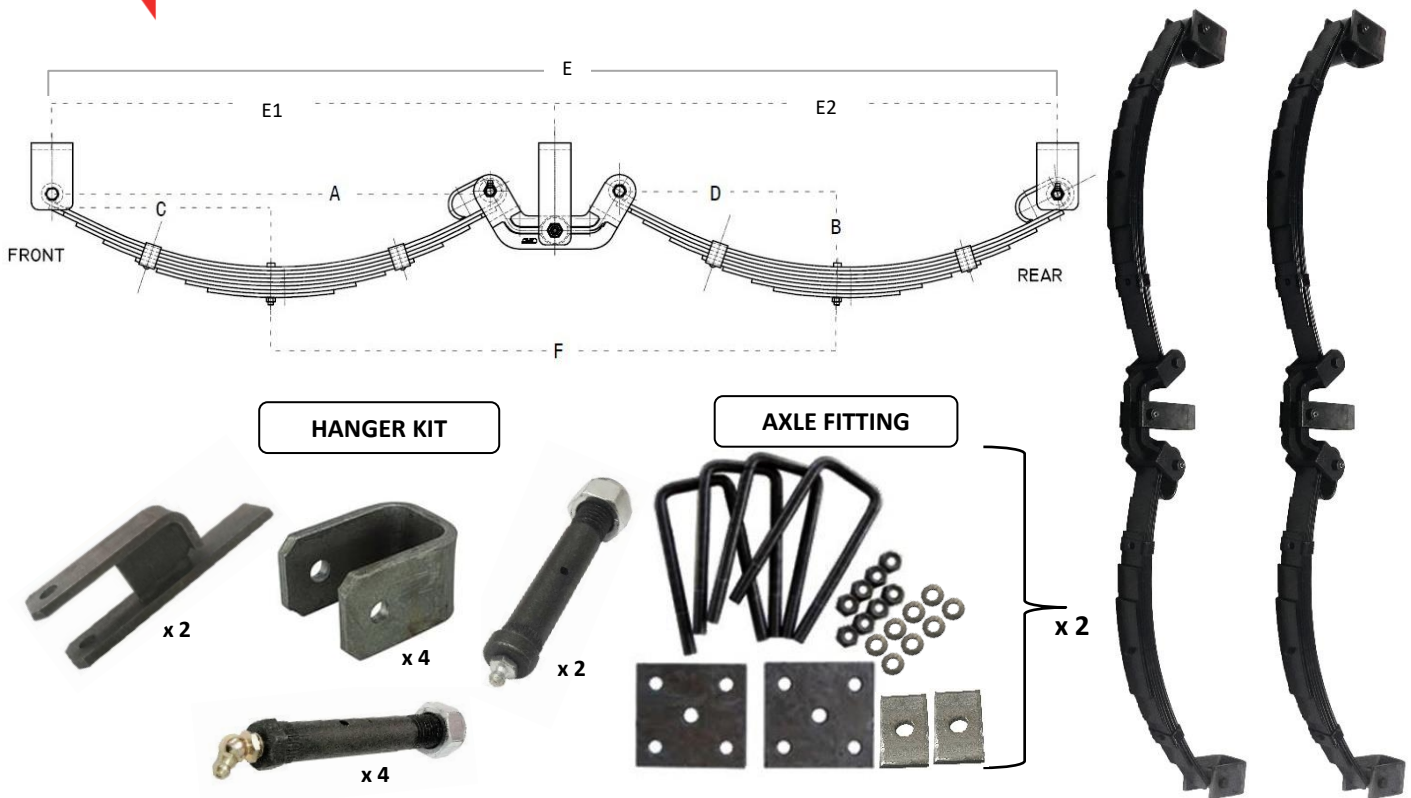

60MM x 6MM BLACK TANDEM ROCKER ROLLER SPRING SETS

PART NO.	DESCRIPTION	CARRYING CAPACITY	A(mm)	B(mm)	C(mm)	D(mm)	E(mm)	E1=E2 (mm)	F(mm)	
SRR605-14S	SET AK. 5L x 60mm x 6mm TANDEM ROCKER ROLLER SPRING*	1900-2200KG	687	117	396	291	1574	787	785	
SRR606-14S	SET AK. 6L x 60mm x 6mm TANDEM ROCKER ROLLER SPRING*	2210-2500KG								
SRR607-14S	SET AK. 7L x 60mm x 6mm TANDEM ROCKER ROLLER SPRING*	2600-3000KG								
SRR606-16S	SET AK. 6L x 60mm x 6mm TANDEM ROCKER ROLLER SPRING*	2900-3200KG			343	343				888
SRR607-16S	SET AK. 7L x 60mm x 6mm TANDEM ROCKER ROLLER SPRING*	3250-4200KG								
SRR608-16S	SET AK. 8L x 60mm x 6mm TANDEM ROCKER ROLLER SPRING*	3800-4490KG								

PLEASE NOTE: SET OF SPRINGS INC. SPRINGS, HANGER KIT & 1/2" AXLE FITTINGS

PLEASE NOTE: SET OF 8L TDM R/ROLLER SPRINGS c/w HANGER KIT & 5/8" AXLE FITTINGS

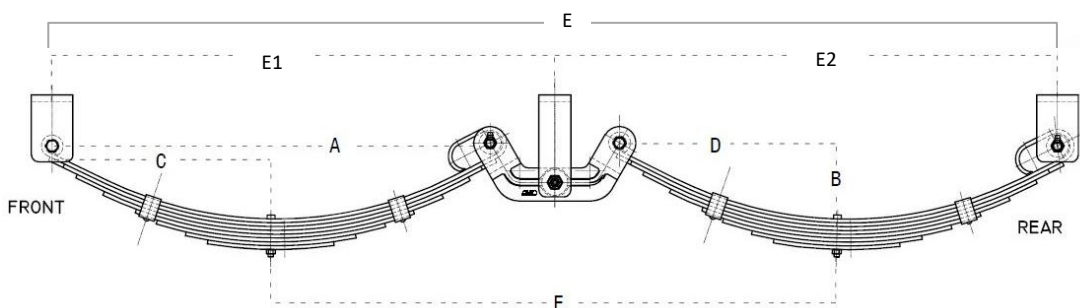

AXLE FITTING



**60MM x 6MM & 7MM
TANDEM ROCKER ROLLER
SPRING SETS**

PART NO.	DESCRIPTION	CARRYING CAPACITY	A(mm)	B(mm)	C(mm)	D(mm)	E(mm)	E1=E2 (mm)	F(mm)
SASRR605-14S	SET SAT 5L x 60mm x 6mm TANDEM ROCKER ROLLER SPRING (14") *	2000KG	695	102	395	290	1584	795	795
SASRR606-14S	SET SAT 6L x 60mm x 6mm TANDEM ROCKER ROLLER SPRING (14") *	2500KG							
SASRR607-14S	SET SAT 7L x 60mm x 6mm TANDEM ROCKER ROLLER SPRING (14") *	3000KG							
SASRR608-14S	SET SAT 8L x 60mm x 6mm TANDEM ROCKER ROLLER SPRING (14") *	4000KG							
SASRR606-16S	SET SAT 6L x 60mm x 7mm TANDEM ROCKER ROLLER SPRING (16") *	2500KG	690	102	345	360	1584	795	920
SASRR607-16S	SET SAT 7L x 60mm x 7mm TANDEM ROCKER ROLLER SPRING (16") *	3000KG							
SASRR608-16S	SET SAT 8L x 60mm x 7mm TANDEM ROCKER ROLLER SPRING (16") *	4000KG							
SASRR609-16S	SET SAT 9L x 60mm x 7mm TANDEM ROCKER ROLLER SPRING (16") *	4500KG							

PLEASE NOTE: SET OF SPRINGS INC. SPRINGS c/w HANGER & 1/2" AXLE FITTINGS

PLEASE NOTE: SET OF 8L & 9L (16") TDM R/ROLLER SPRINGS c/w HANGER & 5/8" AXLE FITTINGS 168

AK HANGERS



590630

FRONT HANGER TO
 SUIT 60MM OUTBACK
 SPRING



590631

REAR HANGER TO
 SUIT 60MM OUTBACK
 SPRING



576302

FRONT HANGER &
 REAR HANGER TO
 SUIT 60MM T/R/R
 SPRING



590703

AK CENTRE ROCKER POST
 ONLY SUIT 18MM PIN &
 T/R SPRING



576305

AK CENTRE ROLLER ROCKER
 POST ONLY SUIT 18MM PIN
 & T/R/R SPRING

AK ARM



590705

AK ROCKER ARM ONLY
 SUIT 60MM SPRING &
 18MM PIN



576303

AK ROLLER ROCKER ARM
 ONLY SUIT 60MM SPRING
 & 18MM PIN

AK PIN



(ROUND HEAD)

590711/12

AK 18MM x 100MM GREASER
 PIN c/w NYLOC NUT TO SUIT
 T/R SPRING



590707/8

AK M16MM x 100MM DRY
 SHACKLE PIN & NYLOC NUT
 TO SUIT T/R SPRING



(HEX HEAD)

576306/12

AK M18MM x 97MM CENTER
 GREASER PIN c/w NYLOC NUT TO
 SUIT T/R/R SPRING



576304/590708

AK M16 GREASER PIN &
 NYLOC NUT TO SUIT T/R/R
 SPRING



590632/708

AK M16 x 100MM GREASER
 PIN c/w NYLOC NUT TO
 SUIT OUTBACK SPRING

AK BUSHES



590633

STEEL BUSH TO SUIT
60MM OUTBACK
SPRING



576301

ROCKER ROLLER
BUSH



590003

16MM x 22MM x
60MM NYLON BUSH
TO SUIT T/R & T/R/R
SPRING

AK FISHPLATE, SHACKLE PLATE & AXLE PAD



590713

SHACKLE PLATE SUIT TO
60MM OUTBACK T/R
SPRING & 16MM PIN



590510/6

FLAT AXLE PAD 8MM
& 10MM



590420

SLOTTED FISHPLATE
60MM x 45 & 50MM

AK U-BOLTS, NUT & WASHER



592506

5/8" U-BOLT c/w NW SUIT 50
SQUARE (170MM LONG)



592455

5/8" U-BOLT c/w NW SUIT 45
SQUARE (160MM LONG)

AK SET OF U-BOLTS c/w NW, AXLE PAD & FISHPLATES

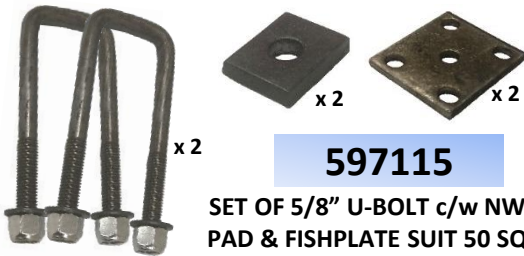

597115

SET OF 5/8" U-BOLT c/w NW AXLE
PAD & FISHPLATE SUIT 50 SQUARE



597115

SET OF 5/8" U-BOLT c/w NW AXLE
PAD & FISHPLATE SUIT 45 SQUARE

**SQUARE BLACK U-BOLT c/w
NUTS & WASHERS**

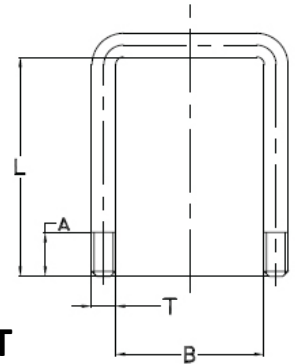

SQUARE U-BOLT

PART NO.	AXLE SECTION "B"	U BOLT LENGTH "L"	NORMAL THREAD LENGTH "A"	THREAD TYPE "T"	FINISH
UB4035SQ	40MM	3.1/2"/89MM	50MM	1/2" BSW	BLACK
UB4045SQ	40MM	4.1/2"/115MM	50MM	1/2" BSW	BLACK
UB405SQ	40MM	5"/127MM	50MM	1/2" BSW	BLACK
UB4055SQ	40MM	5.1/2"/140MM	50MM	1/2" BSW	BLACK
UB4535SQ	45MM	3.1/2"/89MM	50MM	1/2" BSW	BLACK
UB4545SQ	45MM	4.1/2"/115MM	50MM	1/2" BSW	BLACK
UB455SQ	45MM	5"/127MM	50MM	1/2" BSW	BLACK
UB4555SQ	45MM	5.1/2"/140MM	50MM	1/2" BSW	BLACK
UB456SQ	45MM	6"/153MM	50MM	1/2" BSW	BLACK
UB5045SQ	50MM	4.1/2"/115MM	50MM	1/2" BSW	BLACK
UB505SQ	50MM	5"/127MM	50MM	1/2" BSW	BLACK
UB5055SQ	50MM	5.1/2"/140MM	50MM	1/2" BSW	BLACK
UB506SQ	50MM	6"/165MM	50MM	1/2" BSW	BLACK
UB5065SQ	50MM	6.1/2"/153MM	50MM	1/2" BSW	BLACK

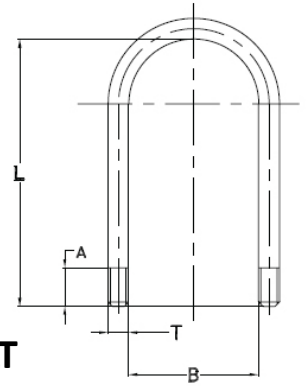

ROUND U-BOLT

**ROUND BLACK U-BOLT c/w
NUTS & WASHERS**

PART NO.	AXLE SECTION "B"	U BOLT LENGTH "L"	NORMAL THREAD LENGTH "A"	THREAD TYPE "T"	FINISH
UB3935RD	39MM	3.1/2"/89MM	50MM	1/2" BSW	BLACK
UB394RD	39MM	4"/115MM	50MM	1/2" BSW	BLACK
UB3945RD	39MM	4.1/2"/102MM	50MM	1/2" BSW	BLACK
UB395RD	39MM	5"/127MM	50MM	1/2" BSW	BLACK
UB3955RD	39MM	5.1/2"/140MM	50MM	1/2" BSW	BLACK
UB5045RD	50MM	4.1/2"/115MM	50MM	1/2" BSW	BLACK
UB505RD	50MM	5"/127MM	50MM	1/2" BSW	BLACK
UB5055RD	50MM	5.1/2"/140MM	50MM	1/2" BSW	BLACK
UB506RD	50MM	6"/153MM	50MM	1/2" BSW	BLACK

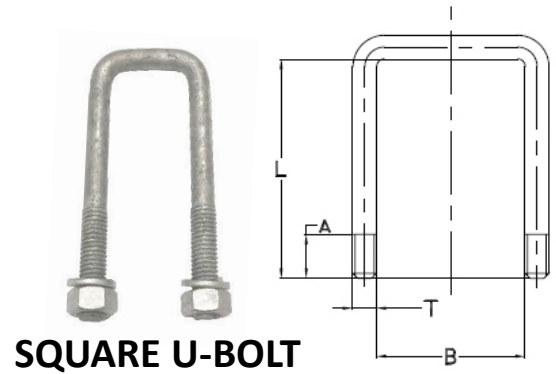

SQUARE U-BOLT

**SQUARE GALVANISED
 U-BOLT c/w NUTS & WASHERS**

PART NO.	AXLE SECTION "B"	U BOLT LENGTH "L"	NORMAL THREAD LENGTH "A"	THREAD TYPE "T"	FINISH
UB4035SQG	40MM	3.1/2"/89MM	50MM	1/2" BSW	GALVANISED
UB4045SQG	40MM	4.1/2"/115MM	50MM	1/2" BSW	GALVANISED
UB405SQG	40MM	5"/127MM	50MM	1/2" BSW	GALVANISED
UB4055SQG	40MM	5.1/2"/140MM	50MM	1/2" BSW	GALVANISED
UB4535SQG	45MM	3.1/2"/89MM	50MM	1/2" BSW	GALVANISED
UB4545SQG	45MM	4.1/2"/115MM	50MM	1/2" BSW	GALVANISED
UB455SQG	45MM	5"/127MM	50MM	1/2" BSW	GALVANISED
UB4555SQG	45MM	5.1/2"/140MM	50MM	1/2" BSW	GALVANISED
UB5045SQG	50MM	4.1/2"/115MM	50MM	1/2" BSW	GALVANISED
UB505SQG	50MM	5"/127MM	50MM	1/2" BSW	GALVANISED
UB506SQG	50MM	6"/153MM	50MM	1/2" BSW	GALVANISED

**ROUND GALVANISED
U-BOLT c/w NUTS & WASHERS**

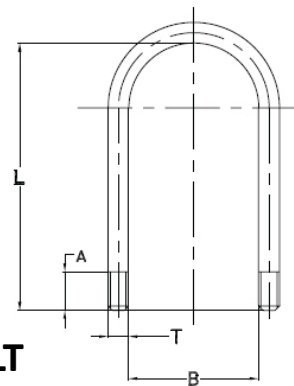

ROUND U-BOLT

PART NO.	AXLE SECTION "B"	U BOLT LENGTH "L"	NORMAL THREAD LENGTH "A"	THREAD TYPE "T"	FINISH
UB3935RDG	39MM	3.1/2"/89MM	50MM	1/2" BSW	GALVANISED
UB3945RDG	39MM	4.1/2"/115MM	50MM	1/2" BSW	GALVANISED
UB395RDG	39MM	5"/127MM	50MM	1/2" BSW	GALVANISED
UB3955RDG	39MM	5.1/2"/140MM	50MM	1/2" BSW	GALVANISED
UB4535RDG	45MM	3.1/2"/89MM	50MM	1/2" BSW	GALVANISED
UB455RDG	45MM	5"/127MM	50MM	1/2" BSW	GALVANISED
UB4555RDG	45MM	5.1/2"/140MM	50MM	1/2" BSW	GALVANISED
UB5045RDG	50MM	4.1/2"/115MM	50MM	1/2" BSW	GALVANISED



FRONT BOLTS & NUTS c/w WASHERS

PART NO.	DESCRIPTION	FINISH
FBNW	FRONT BOLT c/w NUT WASHER (3.1/2" x 1/2")	ZINC
FBNWG	FRONT BOLT GALV c/w NUT WASHER (3.1/2" x 1/2")	GALV



WHIT BOLTS c/w NUTS

PART NO.	DESCRIPTION	FINISH
BN1.5/12	1.1/2" x 1/2" WHIT BOLT c/w NUT	ZINC
BN3.5/12	3.1/2 x 1/2" WHIT BOLT c/w NUT	ZINC
BN4.5/12	4.1/2 x 1/2" WHIT BOLT c/w NUT	ZINC



NUTS & SPRING WASHERS

NUT

WASHER

PART NO.	DESCRIPTION	FINISH
29	1/2" HEX NUT ONLY	ZINC
SWASS12	1/2" SPRING WASHER	ZINC
SWASS38	3/8" SPRING WASHER	ZINC
SWASS716	7/16" SPRING WASHER	ZINC
29G	1/2" GALV HEX NUT ONLY	GALV
SWASS12G	1/2" GALV SPRING WASHER	GALV
SWASS38G	3/8" GALV SPRING WASHER	GALV
SWASS716G	7/16" GALV SPRING WASHER	GALV

**SET OF SQUARE BLACK U-BOLT
c/w NUTS, WASHERS,
FISHPLATES & AXLE PADS**

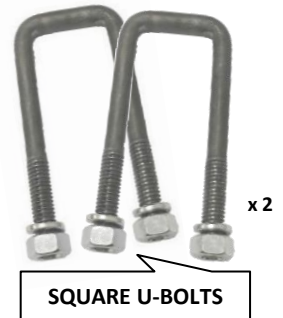
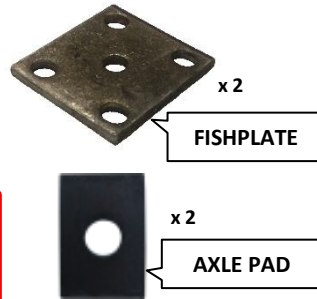

PART NO.	DESCRIPTION
UB4035SSQ	SET OF 40MM SQ x 3.1/2" U-BOLTS c/w NUTS, WASHERS, FISHPLATES & AXLE PADS
UB4045SSQ	SET OF 40MM SQ x 4.1/2" U-BOLTS c/w NUTS, WASHERS, FISHPLATES & AXLE PADS
UB405SSQ	SET OF 40MM SQ x 5" U-BOLTS c/w NUTS, WASHERS, FISHPLATES & AXLE PADS
UB4055SSQ	SET OF 40MM SQ x 5.1/2" U-BOLTS c/w NUTS, WASHERS, FISHPLATES & AXLE PADS
UB4535SSQ	SET OF 45MM SQ x 3.1/2" U-BOLTS c/w NUTS, WASHERS, FISHPLATES & AXLE PADS
UB4545SSQ	SET OF 45MM SQ x 4.1/2" U-BOLTS c/w NUTS, WASHERS, FISHPLATES & AXLE PADS
UB455SSQ	SET OF 45MM SQ x 5" U-BOLTS c/w NUTS, WASHERS, FISHPLATES & AXLE PADS
UB4555SSQ	SET OF 45MM SQ x 5.1/2" U-BOLTS c/w NUTS, WASHERS, FISHPLATES & AXLE PADS
UB456SSQ	SET OF 45MM SQ x 6" U-BOLTS c/w NUTS, WASHERS, FISHPLATES & AXLE PADS
UB5045SSQ	SET OF 50MM SQ x 4.1/2" U-BOLTS c/w NUTS, WASHERS, FISHPLATES & AXLE PADS
UB505SSQ	SET OF 50MM SQ x 5" U-BOLTS c/w NUTS, WASHERS, FISHPLATES & AXLE PADS
UB5055SSQ	SET OF 50MM SQ x 5.1/2" U-BOLTS c/w NUTS, WASHERS, FISHPLATES & AXLE PADS
UB506SSQ	SET OF 50MM SQ x 6" U-BOLTS c/w NUTS, WASHERS, FISHPLATES & AXLE PADS
UB5065SSQ	SET OF 50MM SQ x 6.1/2" U-BOLTS c/w NUTS, WASHERS, FISHPLATES & AXLE PADS

**SET OF ROUND BLACK U-BOLT
c/w NUTS, WASHERS,
FISHPLATE & AXLE PADS**

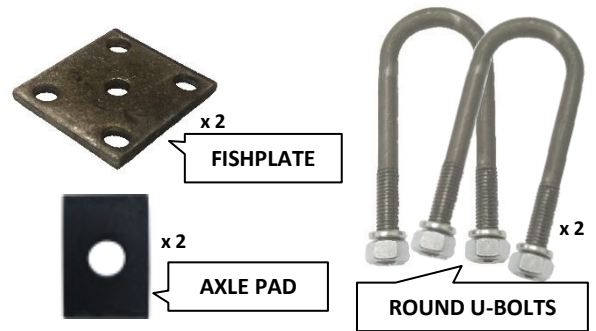

PART NO.	DESCRIPTION
UB3935SRD	SET OF 39MM RD x 3.1/2" U-BOLTS c/w NUTS, WASHERS, FISHPLATES & AXLE PADS
UB3945SRD	SET OF 39MM RD x 4.1/2" U-BOLTS c/w NUTS, WASHERS, FISHPLATES & AXLE PADS
UB394SRD	SET OF 39MM RD x 4" U-BOLTS c/w NUTS, WASHERS, FISHPLATES & AXLE PADS
UB395SRD	SET OF 39MM RD x 5" U-BOLTS c/w NUTS, WASHERS, FISHPLATES & AXLE PADS
UB3955SRD	SET OF 39MM RD x 5.1/2" U-BOLTS c/w NUTS, WASHERS, FISHPLATES & AXLE PADS
UB5045SRD	SET OF 50MM RD x 4.1/2" U-BOLTS c/w NUTS, WASHERS, FISHPLATES & AXLE PADS
UB505SRD	SET OF 50MM RD x 5" U-BOLTS c/w NUTS, WASHERS, FISHPLATES & AXLE PADS
UB5055SRD	SET OF 50MM RD x 5.1/2" U-BOLTS c/w NUTS, WASHERS, FISHPLATES & AXLE PADS
UB506SRD	SET OF 50MM RD x 6" U-BOLTS c/w NUTS, WASHERS, FISHPLATES & AXLE PADS

**SET OF SQUARE GALVANISED
U-BOLT c/w NUTS, WASHERS,
FISHPLATES & AXLE PADS**

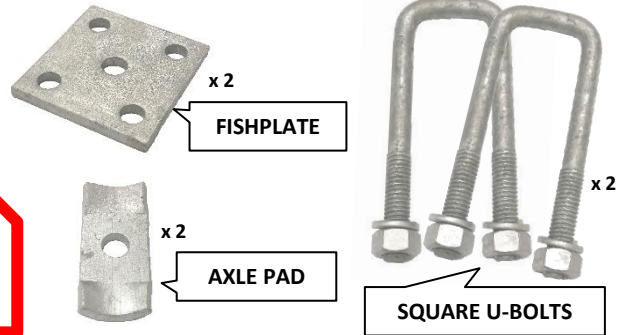

PART NO.

DESCRIPTION

UB4035SSQG	SET OF 40MM SQ x 3.1/2" U-BOLTS c/w NUTS, WASHERS, FISHPLATES & AXLE PADS
UB4045SSQG	SET OF 40MM SQ x 4.1/2" U-BOLTS c/w NUTS, WASHERS, FISHPLATES & AXLE PADS
UB405SSQG	SET OF 40MM SQ x 5" U-BOLTS c/w NUTS, WASHERS, FISHPLATES & AXLE PADS
UB4055SSQG	SET OF 40MM SQ x 5.1/2" U-BOLTS c/w NUTS, WASHERS, FISHPLATES & AXLE PADS
UB4535SSQG	SET OF 45MM SQ x 3.1/2" U-BOLTS c/w NUTS, WASHERS, FISHPLATES & AXLE PADS
UB4545SSQG	SET OF 45MM SQ x 4.1/2" U-BOLTS c/w NUTS, WASHERS, FISHPLATES & AXLE PADS
UB455SSQG	SET OF 45MM SQ x 5" U-BOLTS c/w NUTS, WASHERS, FISHPLATES & AXLE PADS
UB4555SSQG	SET OF 45MM SQ x 5.1/2" U-BOLTS c/w NUTS, WASHERS, FISHPLATES & AXLE PADS
UB5045SSQG	SET OF 50MM SQ x 4.1/2" U-BOLTS c/w NUTS, WASHERS, FISHPLATES & AXLE PADS
UB505SSQG	SET OF 50MM SQ x 5" U-BOLTS c/w NUTS, WASHERS, FISHPLATES & AXLE PADS
UB506SSQG	SET OF 50MM SQ x 6" U-BOLTS c/w NUTS, WASHERS, FISHPLATES & AXLE PADS

**SET OF ROUND GALVANISED
 U-BOLT c/w NUTS, WASHERS,
 FISHPLATES & AXLE PADS**

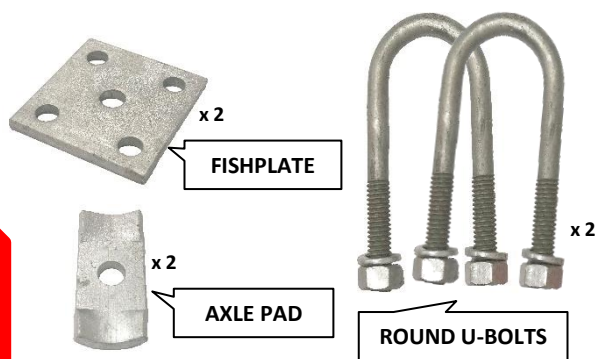

PART NO.	DESCRIPTION
UB3935SRDG	SET OF 39MM SQ x 3.1/2" U-BOLTS c/w NUTS, WASHERS, FISHPLATES & AXLE PADS
UB3945SRDG	SET OF 39MM SQ x 4.1/2" U-BOLTS c/w NUTS, WASHERS, FISHPLATES & AXLE PADS
UB395SRDG	SET OF 39MM SQ x 5" U-BOLTS c/w NUTS, WASHERS, FISHPLATES & AXLE PADS
UB3955SRDG	SET OF 39MM SQ x 5.1/2" U-BOLTS c/w NUTS, WASHERS, FISHPLATES & AXLE PADS
UB4535SRDG	SET OF 45MM SQ x 3.1/2" U-BOLTS c/w NUTS, WASHERS, FISHPLATES & AXLE PADS
UB455SRDG	SET OF 45MM SQ x 5" U-BOLTS c/w NUTS, WASHERS, FISHPLATES & AXLE PADS
UB4555SRDG	SET OF 45MM SQ x 5.1/2" U-BOLTS c/w NUTS, WASHERS, FISHPLATES & AXLE PADS
UB5045SRDG	SET OF 50MM SQ x 4.1/2" U-BOLTS c/w NUTS, WASHERS, FISHPLATES & AXLE PADS



FISHPLATE

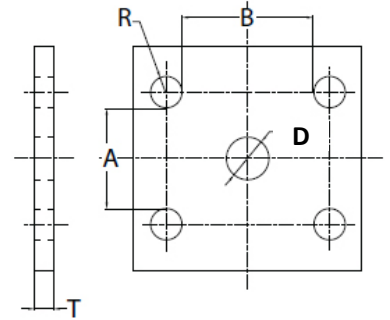

FISH PLATES (PUNCHED HOLE)

PART NO.	DESCRIPTION	SURFACE FINISH	A(MM)	B(MM)	D(MM)	T(MM)
FP3945	FISH PLATE	BLACK	39	45	16	8
FP3960	FISH PLATE	BLACK	39	60	16	7
FP4560	FISH PLATE	BLACK	45	60	21	8
FP5045	FISH PLATE	BLACK	50	45	17	8
FP5060	FISH PLATE	BLACK	50	60	16	8
FP3945G	FISH PLATE	GALV	39	45	15	7
FP5045G	FISH PLATE	GALV	50	45	19	8

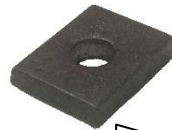

AXLE PAD

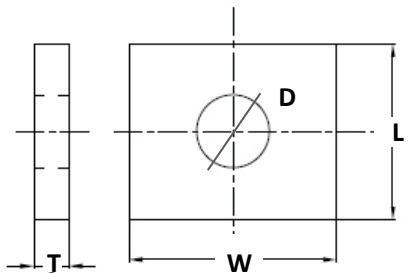

AXLE PADS

PART NO.	DESCRIPTION	SURFACE FINISH	W(MM)	L(MM)	D(MM)	T(MM)
AP1	AXLE PAD	BLACK	40	85	15	7
1146/1	FLAT AXLE PAD	BLACK	45	75	20	7
AP1G	AXLE PAD	GALV	40	85	15	7



STEEL BUSH

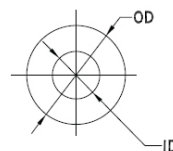
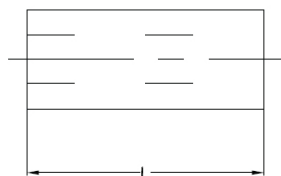

STEEL BUSHES

PART NO.	DESCRIPTION	SURFACE FINISH	OD	ID	L(MM)
9032	STEEL BUSH	BLACK	3/4"	1"	64MM
9046	STEEL BUSH	BLACK	1.1/4"	1"	64MM
SB134	STEEL BUSH	BLACK	3/4"	1"	60MM
IES1057/5	STEEL BUSH (SUIT R/R)	BLACK	5/8"	1.1/4"	60MM
9034	STEEL BUSH	BLACK	7/8"	1.1/8"	64MM
9044	STEEL BUSH	BLACK	1.3/8"	1.1/8"	64MM
SB3458	STEEL BUSH	BLACK	5/8"	3/4"	45MM
SB34916	STEEL BUSH	BLACK	9/16"	3/4"	45MM
SB7834	STEEL BUSH	BLACK	7/8"	3/4"	45MM
SB783460	STEEL BUSH	BLACK	7/8"	3/4"	60MM
SB785860	STEEL BUSH	BLACK	7/8"	5/8"	60MM
SB78916	STEEL BUSH	BLACK	7/8"	9/16"	45MM

NYLON BUSHES



NYLON BUSH

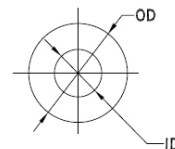

PART NO.	DESCRIPTION	SURFACE FINISH	OD	ID	L(MM)
NB1	NYLON BUSH	BLACK	3/4"	1/2"	45MM
NB2	NYLON BUSH	BLACK	7/8"	1/2"	45MM
NB12B	NYLON BUSH	BLACK	7/8"	1/2"	45MM
IES1057/2	NYLON BUSH (SUIT R/R)	BLACK	5/8"	1.1/4"	60MM
NB34916	NYLON BUSH	BLACK	9/16"	3/4"	45MM
NB58B	NYLON BUSH	BLACK	7/8"	5/8"	57MM
NB785860	NYLON BUSH	BLACK	7/8"	5/8"	60MM
NB78916	NYLON BUSH	BLACK	9/16"	7/8"	45MM

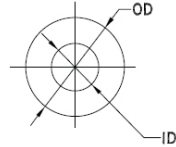
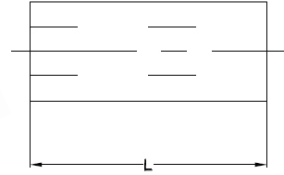

NYLON BUSHES

NYLON BUSH

STEEL BUSH

PART NO.	DESCRIPTION	SURFACE FINISH	OD	ID	L(MM)
NB1PK2	PACK OF 2 NYLON BUSH	BLACK	3/4"	1/2"	45MM
NB1PK4	PACK OF 4 NYLON BUSH	BLACK	3/4"	1/2"	45MM
NB2PK2	PACK OF 2 NYLON BUSH	BLACK	7/8"	1/2"	45MM
NB2PK4	PACK OF 4 NYLON BUSH	BLACK	7/8"	1/2"	45MM
IES1057/2PK2	PACK OF 2 NYLON BUSH (SUIT R/R)	BLACK	5/8"	1.1/4"	60MM
IES1057/2PK	PACK OF 4 NYLON BUSH (SUIT R/R)	BLACK	5/8"	1.1/4"	60MM
NB34916PK2	PACK OF 2 NYLON BUSH	BLACK	9/16"	3/4"	45MM
NB34916PK4	PACK OF 4 NYLON BUSH	BLACK	9/16"	3/4"	45MM
NB785860PK2	PACK OF 2 NYLON BUSH	BLACK	7/8"	5/8"	60MM
NB785860PK4	PACK OF 4 NYLON BUSH	BLACK	7/8"	5/8"	60MM
NB78916PK2	PACK OF 2 NYLON BUSH	BLACK	9/16"	7/8"	45MM
NB78916PK4	PACK OF 4 NYLON BUSH	BLACK	9/16"	7/8"	45MM

STEEL BUSHES

PART NO.	DESCRIPTION	SURFACE FINISH	OD	ID	L(MM)
576301PK2	PACK OF 2 STEEL BUSH (SUIT R/R)	BLACK	5/8"	1.1/4"	60MM
576301PK4	PACK OF 4 STEEL BUSH (SUIT R/R)	BLACK	5/8"	1.1/4"	60MM



NYLON BUSHES c/w FRONT BOLT



PART NO.	DESCRIPTION
NB3412FB/2	PACK OF 2 – 3/4" NYLON BUSHES & 1/2" F/BOLTS
NB3412FB/4	PACK OF 4 – 3/4" NYLON BUSHES & 1/2" F/BOLTS
NBP7812FB/2	PACK OF 2 – 7/8" NYLON BUSHES & 1/2" F/BOLTS
NBP7812FB/4	PACK OF 4 – 7/8" NYLON BUSHES & 1/2" F/BOLTS

NYLON BUSHES OR STEEL c/w GREASER PINS



PART NO.	DESCRIPTION
NBP58DP/4	PACK OF 4 – NYLON BUSHES 7/8 x 5/8 x 60MM & 5/8" G/PINS
SBP58GP/4	PACK OF 4 – STEEL BUSHES & 5/8" G/PINS
SBP58RGP/4	PACK OF 4 – STEEL ROLLER BUSHES & 5/8" G/PINS

NYLON BUSHES c/w DRY PINS



PART NO.	DESCRIPTION
NBP58RDP/4	PACK OF 4 – NYLON ROLLER BUSHES & 5/8" DRY PINS
NBP7858DP/4	PACK OF 4 – 7/8" NYLON BUSHES & 5/8" DRY PINS

SHACKLE PLATES

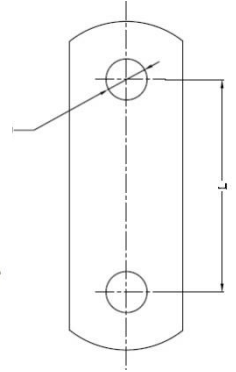

PART NO.	DESCRIPTION	SURFACE FINISH	D	L(MM)
SP12	SHACKLE PLATE	BLACK	1/2"	65MM
SP58	SHACKLE PLATE	BLACK	5/8"	66MM
SP916	SHACKLE PLATE	BLACK	9/16"	66MM

SHACKLE PIN c/w NYLON NUT

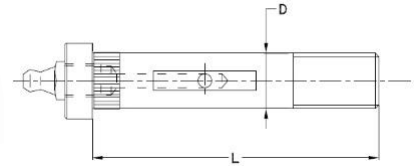

PART NO.	DESCRIPTION	SURFACE FINISH	D	L
SP58334	SHACKLE PIN & NYLON NUT	BLACK	5/8"	3.3/4"
701160	SHACKLE PIN & NYLON NUT	BLACK	5/8"	4"
SP9163	SHACKLE PIN & NYLON NUT	BLACK	9/16"	3"
701150	SHACKLE PIN & NYLON NUT	BLACK	9/16"	3.1/2"

ROCKER ARM

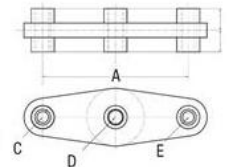

PART NO.	DESCRIPTION	SURFACE FINISH	A	C	D	E
XAR50	ROCKER ARM	BLACK	155MM	23MM	17MM	23MM

GREASER PIN c/w NYLON NUT

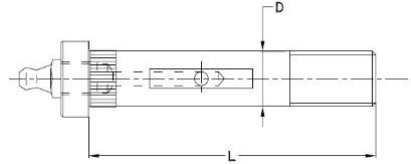

PART NO.	DESCRIPTION	SURFACE FINISH	D	L
GP34312	GREASER PIN & NYLON NUT	BLACK	3/4"	3.1/2
GP34334	GREASER PIN & NYLON NUT	BLACK	3/4"	3.3/4"
GP344	GREASER PIN & NYLON NUT	BLACK	3/4"	4"
GP34412	GREASER PIN & NYLON NUT	BLACK	3/4"	4.1/2"
701142	GREASER PIN & NYLON NUT	BLACK	5/8"	3.1/2"
701162	GREASER PIN & NYLON NUT	BLACK	5/8"	4"
GP58314	GREASER PIN & NYLON NUT	BLACK	5/8"	3.1/4"
GP58412	GREASER PIN & NYLON NUT	BLACK	5/8"	4.1/2"
701140	GREASER PIN & NYLON NUT	BLACK	9/16"	3.1/2"
GP916314	GREASER PIN & NYLON NUT	BLACK	9/16"	3.1/4"
GP916334	GREASER PIN & NYLON NUT	BLACK	9/16"	3.3/4"
GP9164	GREASER PIN & NYLON NUT	BLACK	9/16"	4"

GREASE NIPPLE



PART NO.	DESCRIPTION
H29	GREASE NIPPLE

REAR HANGERS



RH45P

REAR SPRING
 HANGER
 (45MM PARABOLIC)



RH45PG

REAR SPRING
 HANGER GALV
 (45MM PARABOLIC)



SAT9060

REAR SPRING
 HANGER STD.
 EYE & EYE
 (45MM X 1/2")



RH45

REAR SPRING
 HANGER STD
 (45MM SLIPPER)



RH45G

REAR SPRING
 HANGER STD GALV
 (45MM SLIPPER)

LONG CENTRE HANGERS



LCH

LONG CENTRE
 HANGER [1/2"]



LCHG

GALV. LONG CENTRE
 HANGER [1/2"]

FRONT HANGERS



FH4512

FRONT SPRING
 HANGER STD
 [1/2" X 45MM]



FH4512G

FRONT SPRING
 HANGER GALV STD
 [1/2" X 45MM]

SA

TRAILER

& CHASSIS EQUIPMENT

SHOCKER

- **ALKO SHOCKERS**
- **KYB SHOCKER**



136 Port Wakefield Road, CAVAN SA 5094

Ph. 08 8262 7170 Fax. 08 8262 6123

www.satrailer.com.au



BEAM MOUNT SHOCK ABSORBER

When a traditional sprung axle requires an improved smoother ride, shock absorbers are an economical and simple enhancement. Rough roads and corrugations can cause vibration that can cause premature failure of trailer components, shock absorbers are a possible solution to improve the spring rate in relation to bumps in the road and reduce the amount of vibration.

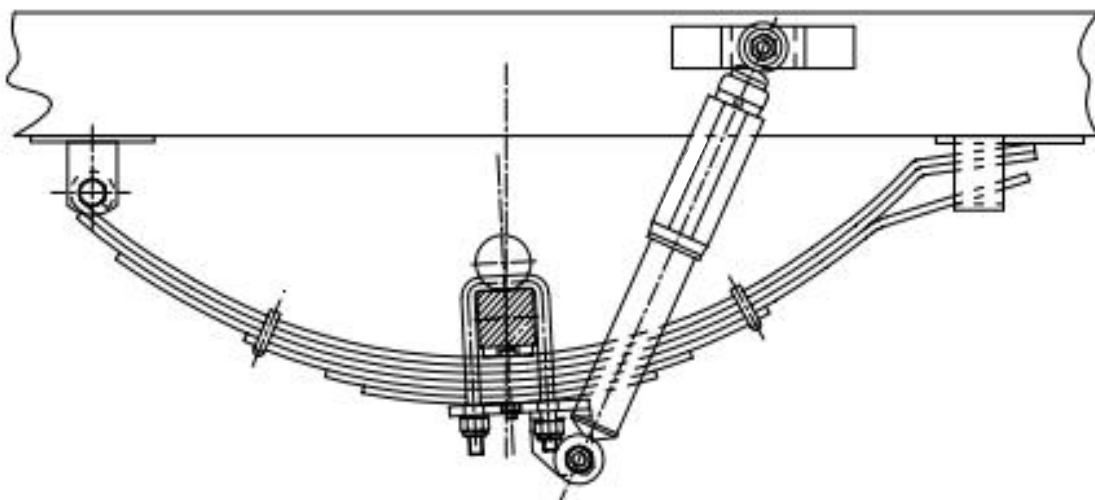
Please note adding shock absorbers does not increase the carrying of the suspension.



PART NO.	DESCRIPTION	
151985	AK SHOCK ABSORBER ENDURO - BLACK	
658005	AK SHOCK ABSORBER KIT (BLACK) (SUIT BEAM AXLES)	
280000	AK BLUE SHOCKER - EA (SUIT ALKO AXLES)	
658005	AK SHOCK ABSORBER KIT (BLACK) (SUIT BEAM AXLES)	
8452051	KYB SHOCKER - CRUISEMASTER - XT FREESTYLE - REPLACEMENT OEM PART NO. #33J2900	
8452052	KYB SHOCKER - SIMPLICITY - SMART COIL 7 AIRBAG - REPLACEMENT OEM PART NO. #400444	
8452053	KYB SHOCKER - ALPHA SUSPENSION & SUNRISE	

PART NO.	DESCRIPTION	
8452054	KYB SHOCKER - G & S CHASSIS - CONTROL RIDER TS - REPLACEMENT OEM PART NO. #83900TS	
8452055	KYB SHOCKER - AL-KO - REPLACEMENT OEM PART NO. #207693, 208353, P151980 & P158985	
8452056	KYB SHOCKER - JAYCO - REPLACEMENT OEM PART NO. #J-TECH 1.0 & J-TECH 2.0 - JAYCO 40 & C1056M	

STANDS & PARTS



- AL-KO
- SIMOL
- SAT
- TRAIL-A-MATE



136 Port Wakefield Road, CAVAN SA 5094

Ph. 08 8262 7170 Fax. 08 8262 6123

www.satrailer.com.au

The AL-KO Landing Leg is the latest addition to AL-KO's extensive range of quality trailer components. Ideal for stabilising plant trailers, camper trailers, 5 wheeler caravans and agricultural equipment, the AL-KO Landing Leg is a necessary inclusion to the toolkit of the commercial contractor, farmer and camping enthusiast alike. All bases are covered with the AL-KO range of Landing Legs, with static loads ranging from 1,300 to 4,500kg. An AL-KO Landing Leg can also be fitted to another brands existing mounting kit. The AL-KO Landing Leg is your ideal choice when looking to safely and efficiently stabilise your trailer, camper, 5 wheeler caravan or agricultural machinery.

PART NO.	OUTER TUBE MM ²	TUBE MOUNT FITTED	WEIGHT KG	LOAD CAPACITY KG	SURFACE FINISH	A1	A2	B	C	D
622057	57.5RD	Yes	6.7	1300	Zinc	550	900	400	167	118
622057L	57.5RD	Yes	9.1	1300	Zinc	1060	1440	910	167	118
622070	70.0SQ	No	11.8	1500	Zinc	595	1275	-	167	118
622070WTM	70.0SQ	Yes	12.3	1500	Zinc	595	1275	-	167	118
622071	70.0SQ	No	9.9	2000	Zinc	580	940	-	167	118
622071WTM	70.0SQ	Yes	10.4	2000	Zinc	580	940	430	167	118
622110	110 SQ	No	32.9	4500	Zinc	690	1275	-	326	250
622000	Chassis Mount & Tube Bracket Kit				Zinc	-				





When rigid stability is required the AL-KO range of stands fits the bill. Available in varying heights and also in weld on swivel bracket versions.

These steady stands are ideal for fixed location stabilizing of trailers and plant equipment.

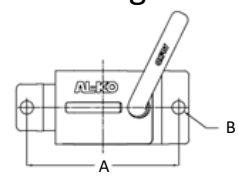
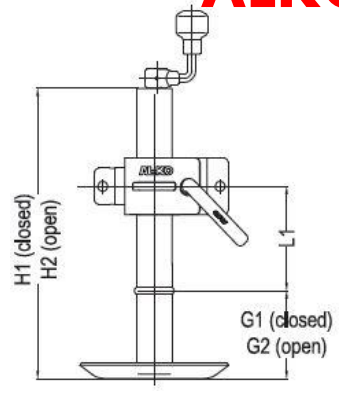

AS14

PART NO.	OUTER TUBE MM ²	TUBE MOUNT FITTED	WEIGHT KG	LOAD CAPACITY KG	SURFACE FINISH	H1	H2	G1	G2
AS14	48.0RD	N/A	4.5	400	Zinc	375	625	70	320



AS20

PART NO.	OUTER TUBE MM ²	TUBE MOUNT FITTED	WEIGHT KG	LOAD CAPACITY KG	SURFACE FINISH	H1	H2	G1	G2
AS20	48.0RD	N/A	5.0	400	Zinc	515	765	160	410



AS27

PART NO.	OUTER TUBE MM ²	TUBE MOUNT FITTED	WEIGHT KG	LOAD CAPACITY KG	SURFACE FINISH	H1	H2	G1	G2
AS27	48.0RD	N/A	6.0	400	Zinc	695	945	360	610

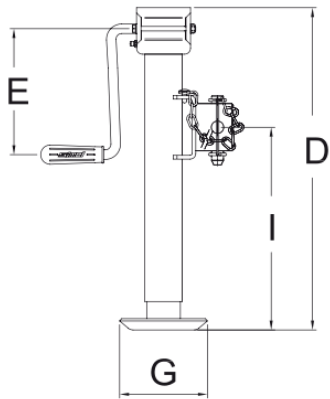

LT3153
57mm RD Side Wind Z/P Tube
Mount Stand no drop leg

PART NO.	OUTER TUBE MM ²	WEIGHT KG	LOAD CAPACITY KG	D (mm)	E (mm)	G (mm)	I (mm)
LT3153	57 RD	7.1	1300	560	168	120 x 165	405

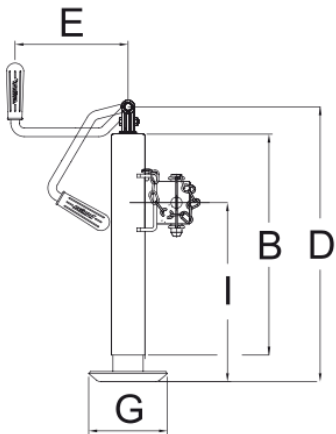

ST3154
57mm RD Top Wind Z/P Tube
Mount Stand no drop leg

PART NO.	OUTER TUBE MM ²	WEIGHT KG	LOAD CAPACITY KG	B (mm)	D (mm)	E (mm)	G (mm)	I (mm)
ST3154	57 RD	6.4	1300	455	535	168	120x165	390

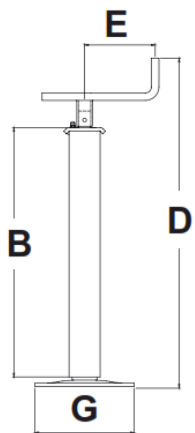

P560
70mm SQ Top Wind Red
Ag Stand no drop leg

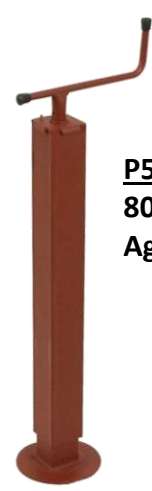

P575
80mm SQ Top Wind Red
Ag Stand no drop leg

PART NO.	OUTER TUBE MM ²	WEIGHT KG	LOAD CAPACITY KG	B (mm)	D (mm)	E (mm)	G (mm)
P560	70 SQ	8.2	1000	500	670	185	160
P575	80 SQ	11	1200	500	670	185	200

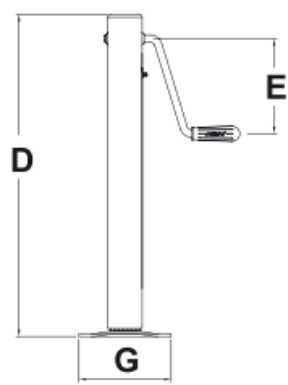

DG590
70mm SQ Side Wind Red Stand &
Bracket (no Drop Leg) 1500kg

PART NO.	OUTER TUBE MM ²	WEIGHT KG	LOAD CAPACITY KG	D (mm)	E (mm)	G (mm)
DG590	70 SQ	8.4	1500	530	175	120x165

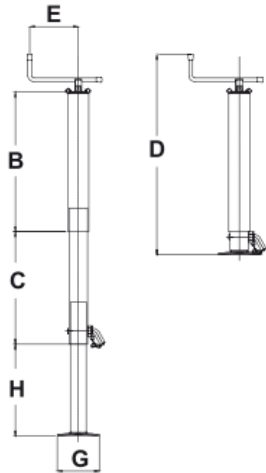

P575/3SF
80mm SQ Top Wind Red Ag Stand
c/w Drop Leg

PART NO.	OUTER TUBE MM ²	WEIGHT KG	LOAD CAPACITY KG	B (mm)	C (mm)	D (mm)	E (mm)	G (mm)	H (mm)
P575/3SF	80 SQ	16.7	1000	530	360	790	185	160	320

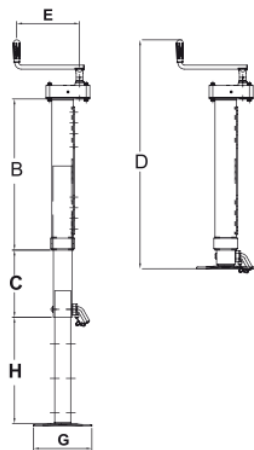

PR675/3SF1
80mm SQ Geared Top Wind Red
Ag Stand & Bracket c/w Drop Leg

PART NO.	OUTER TUBE MM ²	WEIGHT KG	LOAD CAPACITY KG	B (mm)	C (mm)	D (mm)	E (mm)	G (mm)	H (mm)
PR675/3SF1	80 SQ	20	2500	570	300	855	235	220	390

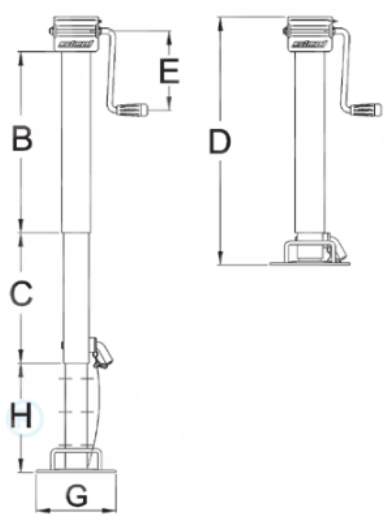

DG706/3SF
80mm Square Side Wind Red Stand (c/w Drop Leg)







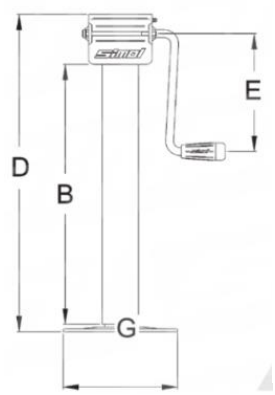

DG706/3SFW
80mm Squ. Side Wind Red Ag Stand (c/w drop leg) (3 speed)

PART NO.	OUTER TUBE MM ²	WEIGHT KG	LOAD CAPACITY KG	B (mm)	C (mm)	D (mm)	E (mm)	G (mm)	H (mm)
DG706/3SF	80 SQ	21	2500	500	290	685	225	220	276
DG706/3SFW	80 SQ	21	2500	500	290	685	225	220	276



DG706W
80mm SQ Side Wind Red Ag Stand no drop leg (2 stage wind)

PART NO.	OUTER TUBE MM ²	WEIGHT KG	LOAD CAPACITY KG	B (mm)	D (mm)	E (mm)	G (mm)
DG706W	80 SQ	13.4	4000	500	620	225	220

PART NO.	DESCRIPTION	SUIT	
F5	FLAT MOUNT PLATE	SQUARE STANDS	
LT/ST0141	WELD ON TUBE	LT2103 LT3153 LR3152/19 ST3154	
LT/ST0151	BOLT ON OR WELD ON TUBE	LR3152/19	
LF/SF0121	WELD ON PLATE	LF3151 SF3152	
040.02	MOUNT PLATE	H1140P	
SIM.DG706/ MAN	PVC HANDLE	PR675/3SF1; PE600; P560; P575; DG590; P575/3SF; DG706W; DG706/3SF; DG706/3SFW	

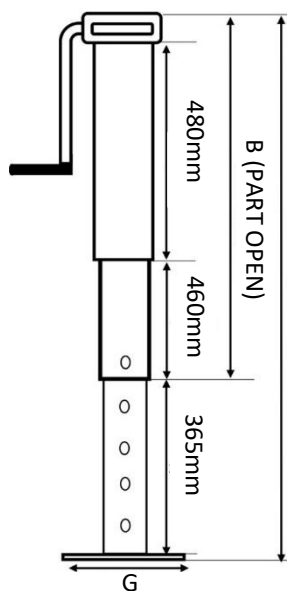

SABD-03E4

2 TON SIDE WIND STAND c/w
DROP LEG no TUBE MOUNT

OUTER TUBE (mm)	LOAD CAPACITY (KG)	SURFACE FINISH	A (CLOSED)	B (PART OPEN)	C (FULLY OPEN)	G
65mm(SQ)	2 TON	GREY	610mm	1020mm	1365mm	201mm x 140mm

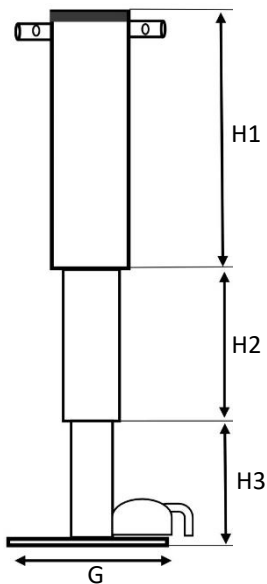

SAS45

4.5 TON ZINC PLATED STAND
c/w DROP LEG



OUTER TUBE (mm)	LOAD CAPACITY (KG)	SURFACE FINISH	D (CLOSED)	H1	H2	H3	G
105mm(SQ)	4.5 TON	ZINC	700mm	612mm	320mm	390mm	202 x 217mm

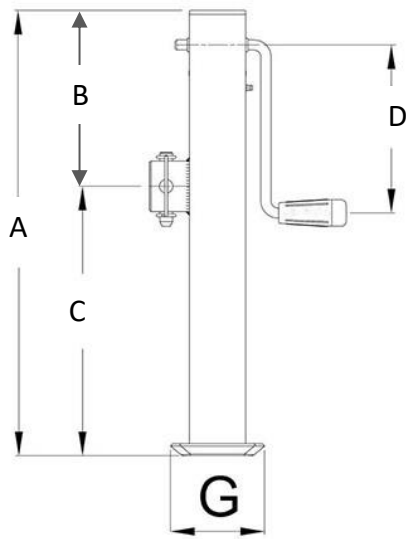

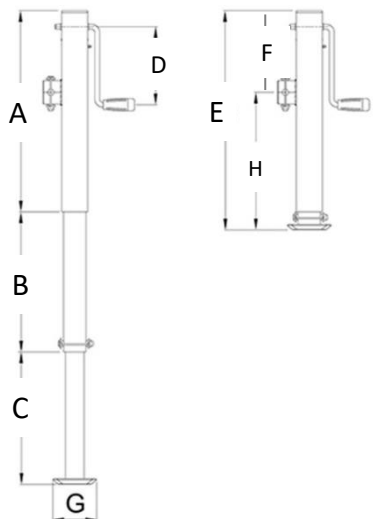

SAS1WTM
SAT 1 TON SIDE WIND STAND
c/w TUBE MOUNT ONLY

OUTER TUBE (mm)	LOAD CAPACITY (KG)	SURFACE FINISH	A(mm) (CLOSED)	A(mm) (OPEN)	B (mm)	C (mm)	D (mm)	G (mm)
57Φ	1 TON	ZINC	420	685	190	230	150	100 x 190



SAS2WTM
SAT 2 TON SIDE WIND STAND
c/w TUBE MOUNT & DROP LEG

OUTER TUBE (mm)	LOAD CAPACITY (KG)	SURFACE FINISH	A (mm)	B (mm)	C (mm)	D (mm)	E(mm) (CLOSED)	E(mm) (OPEN)	F (mm)	G (mm)	H (mm)
63.5 SQ	2 TON	ZINC	555	410	350	220	625	1355	220	100 x 190	410

PART NO.	DESCRIPTION	
SASSOTM	SPARE OUTER TUBE MOUNT TO SUIT SAS1WTM & SAS2WTM	
SASSPC	SPARE PIN & CHAIN FOR TUBE MOUNT TO SUIT SAS1WTM & SAS2WTM	



TMII

TRAIL A MATE MARKII STAND ONLY (NO CLAMP)
AUSTRALIAN MANDATORY SAFETY STANDARDS (2693:2007)

MINIMUM HEIGHT	MAXIMUM HEIGHT	LIFTING RANGE	LOAD LIMIT
145mm	780mm	380mm	1500KG



TMKIT001

TRAIL-A-MATE STAND ONLY (NO CLAMP)
AUSTRALIAN MANDATORY SAFETY STANDARDS (2693:2007)

MINIMUM HEIGHT	MAXIMUM HEIGHT	LIFTING RANGE	LOAD LIMIT
145mm	780mm	380mm	1000KG

PLEASE NOTE: A CLAMP IS NOT INCLUDED

PART NO.	DESCRIPTION
TMIIJ/WCLAMP	60MM J/WHEEL CLAMP to suit 1500KG TRAIL-A-MATE MARK II



SA

TRAILER

& CHASSIS EQUIPMENT



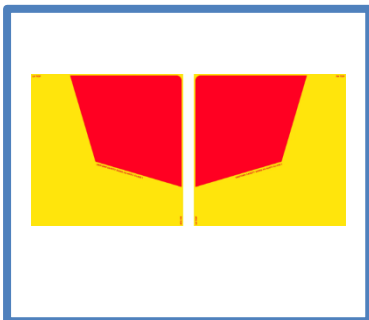
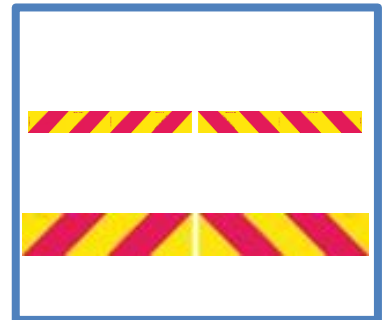
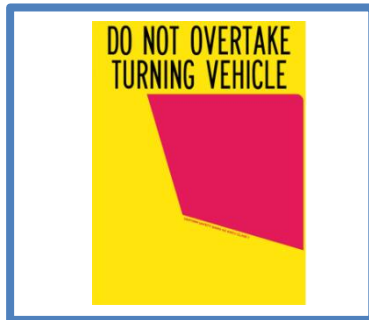



SAFETY & VEHICLE SIGNS



136 Port Wakefield Road, CAVAN SA 5094

Ph. 08 8262 7170 Fax. 08 8262 6123

www.satrailer.com.au

PART NO.	DESCRIPTION	
TC34A-A	<p>REAR MARKER PLATE DONT OVERTAKE TV-300 x 400MM-SELF ADHESIVE CLASS1-LEFT</p>	
TC34A-M	<p>REAR MARKER PLATE DONT OVERTAKE TV-METAL- 300 x 400MM CLASS 1 - LEFT</p>	
TC34B-M	<p>REAR MARKER PLATE DONT OVERTAKE TV-METAL – 300 x 400MM CLASS 1-RIGHT</p>	
TC4001-A	<p>REAR MARKER PLATES -SELF ADHESIVE – 300 x 300MM CLASS 1-RED/YELLOW- PAIR</p>	
TC4001-M	<p>REAR MARKER PLATE METAL - 300 x 300MM CLASS 1 - RED/YELLOW - PAIR</p>	
TC4003-M	<p>DO NOT OVERTAKE TURNING VEHICLE (SQUARE) METAL - REFLECTIVE 300 x 300MM - CLASS 1</p>	

PART NO.	DESCRIPTION	
TC4011-A	CANDY STRIPES - SELF ADHESIVE 800 x 100MM - CLASS 1 - PAIR	
TC4011-M	CANDY STRIPES - METAL 800 x 100MM - CLASS 1 - PAIR	
TC4014-A	CANDY STRIPES - SELF ADHESIVE 400 x 100MM - CLASS1 - PAIR	
TC4014-M	CANDY STRIPES - METAL 400 x 100MM - CLASS 1 - PAIR	
TC402	OVERSIZE - METAL 1200 x 450MM - CLASS2	
TC473	DO NOT OVERTAKE TURNING VEHICLE SELF ADHESIVE – 300 x 100MM - CLASS 1	

SA

TRAILER

& CHASSIS EQUIPMENT



WHEELS & TYRES

- **WHEELS & TYRES**
- **WHEELS ONLY**
- **TYRES ONLY**
- **TYRES c/w TUBES**



136 Port Wakefield Road, CAVAN SA 5094



Ph. 08 8262 7170 Fax. 08 8262 6123

www.satrailer.com.au

GALV

PART NO.	DESCRIPTION	LOAD RATING	
SA13FG165LT	<p>SAT 13 x 4.5 GALV. FORD WHEEL c/w 165R13LT TYRE (WHEEL CAP: 750KG/TYRE CAP: 670KG) PLY RATING: 8PLY</p>	94/93Q	
SA14FG185X	<p>SAT 14 x 6 GALV. FORD WHEEL c/w 185/65R14 TYRE (WHEEL CAP: 850KG/TYRE CAP: 530KG) PLY RATING: 8PLY</p>	86S	
SA14FG185	<p>SAT 14 x 6 GALV. FORD WHEEL c/w 185R14C TYRE (WHEEL CAP: 850KG/TYRE CAP: 825KG) PLY RATING: 8PLY</p>	102/100Q	
SA14FG195	<p>SAT 14 x 6 GALV. FORD WHEEL c/w 195R14LT TYRE (WHEEL CAP: 850KG/TYRE CAP: 925KG) PLY RATING: 8PLY</p>	105/103Q	
SA14HTG185X	<p>SAT 14 x 6 GALV. HT WHEEL c/w 185/65R14 TYRE (WHEEL CAP: 850KG/TYRE CAP: 530KG) PLY RATING: 8PLY</p>	86S	
SA14HTG185	<p>SAT 14 x 6 GALV. HT WHEEL c/w 185R14C TYRE (WHEEL CAP: 850KG/TYRE CAP: 825KG) PLY RATING: 8PLY</p>	102/100Q	
SA14HTG195	<p>SAT 14 x 6 GALV. HT WHEEL c/w 195R14LT TYRE (WHEEL CAP: 850KG/TYRE CAP: 925KG) PLY RATING: 8PLY</p>	105/103Q	







PLEASE NOTE: TYRE BRANDS ARE : LUHE, HAIDA and WANDA & LOAD RATING CAN BE SLIGHTLY HIGHER or LOWER ACCORDING to BRAND)

PART NO.	DESCRIPTION	LOAD RATING	
SA8M2211	8" x 7" MINI WHITE WHEEL c/w 22 x 11 TYRE (WHEEL CAP: 850KG/TYRE CAP: 530KG) PLY RATING: 6PLY		
SA14FW185X	SAT 14 x 6 FORD WHITE WHEEL c/w 185/65R14 TYRE (WHEEL CAP: 850KG/TYRE CAP: 530KG) PLY RATING: 8PLY	86S	
SA14FW185	SAT 14 x 6 FORD WHITE WHEEL c/w 185R14C LH TYRE (Wheel Cap: 850KG/Tyre Cap: 825KG) PLY RATING: 8PLY	102/100Q	
SA14FW185F	SAT 14 x 6 FORD WHITE WHEEL c/w 185R14C HD TYRE (WHEEL CAP: 850KG/TYRE CAP: 825KG) PLY RATING: 8PLY	102/100Q	
SA14HTW185X	SAT 14 x 6 HT WHITE WHEEL c/w 185/65R14 TYRE (WHEEL CAP: 850KG/TYRE CAP: 530KG) PLY RATING: 8PLY	86S	
SA14HTW185	SAT 14 x 6 HT WHITE WHEEL c/w 185R14C TYRE (WHEEL CAP: 850KG/TYRE CAP: 825KG) PLY RATING: 8PLY	102/100Q	
SA14HTW195	SAT 14 x 6 HT WHITE WHEEL c/w 195R14LT TYRE (WHEEL CAP: 850KG/TYRE CAP: 925KG) PLY RATING: 8PLY	105/103Q	



PLEASE NOTE: TYRE BRANDS ARE : LUHE, HAIDA and WANDA & LOAD RATING CAN BE SLIGHTLY HIGHER or LOWER ACCORDING to BRAND

PART NO.	DESCRIPTION	LOAD RATING	
SA14FW185X	SAT 14 x 6 FORD WHITE WHEEL c/w 185/65R14 TYRE (Wheel Cap: 850KG/Tyre Cap: 530KG) PLY RATING: 8PLY	86S	
SA14Hqw185X	SAT 14 x 6 HQ WHITE WHEEL c/w 185/65R14 TYRE (WHEEL CAP: 850KG/TYRE CAP: 530KG) PLY RATING: 8PLY	86S	
SA14Hqw185	SAT 14 x 6 HQ WHITE WHEEL c/w 185R14C TYRE (WHEEL CAP: 850KG/TYRE CAP: 825KG) PLY RATING: 8PLY	102/100Q	
SA14Hqw195	SAT 14 x 6 HQ WHITE WHEEL c/w 195R14LT TYRE (WHEEL CAP: 850KG/TYRE CAP: 925KG) PLY RATING: 8PLY	105/103Q	
SA14LCW185	SAT 14 x 6 T/LC 6 WHITE WHEEL c/w 185R14C TYRE (WHEEL CAP: 850KG/TYRE CAP: 825KG) PLY RATING: 8PLY	102/100Q	
SA14LCW195	SAT 14 x 6 T/LC 6 WHITE WHEEL c/w 195R14LT TYRE (WHEEL CAP: 850KG/TYRE CAP: 925KG) PLY RATING: 8PLY	105/103Q	
SA15FW195	SAT 15 x 6 FORD WHITE WHEEL c/w 195R15LT TYRE (WHEEL CAP: 1150KG/TYRE CAP: 950KG) PLY RATING: 8PLY	106/104Q	

PLEASE NOTE: TYRE BRANDS ARE : LUHE, HAIDA and WANDA & LOAD RATING CAN BE SLIGHTLY HIGHER or LOWER ACCORDING to BRAND)

PART NO.	DESCRIPTION	LOAD RATING	
SA156LCW195	<p>SAT 15 x 6 T/LC 6 WHITE WHEEL c/w 195R15LT TYRE [WHEEL CAP: 1150KG/TYRE CAP: 950KG] PLY RATING: 8PLY</p>	106/104Q	
SA15LCW225	<p>SAT 15 x 7 T/LC 6 WHITE WHEEL c/w 225/70R15 TYRE (WHEEL CAP: 1150KG/TYRE CAP: 1120KG) PLY RATING: 8PLY</p>	106/104Q	
SA15LCW235	<p>SAT 15 x 7 T/LC 6 WHITE WHEEL c/w 235/75R15 WD TYRE (WHEEL CAP: 1150KG/TYRE CAP: 900KG) PLY RATING: 6PLY</p>	104/101S	
SA15LCW235F	<p>SAT 15 x 7 T/LC 6 WHITE WHEEL c/w 235/75R15 HD TYRE (WHEEL CAP: 1150KG/TYRE CAP: 900KG) PLY RATING: 6PLY</p>	104/101S	
SA15LCW31105	<p>SAT 15 x 7 T/LC 6 WHITE WHEEL c/w 31X10.5R15 TYRE (WHEEL CAP: 1150KG/TYRE CAP: 1030KG) PLY RATING: 6PLY</p>	109S	
SA166LCW750	<p>SAT 16 x 6 T/LC 6 WHITE WHEEL c/w 7.50R16 TYRE (WHEEL CAP: 1700KG TYRE CAP: 1500KG) PLY RATING: 14PLY</p>	122/118N	

PLEASE NOTE: TYRE BRANDS ARE : LUHE, HAIDA and WANDA & LOAD RATING CAN BE SLIGHTLY HIGHER or LOWER ACCORDING to BRAND)

PART NO.	DESCRIPTION	LOAD RATING	
SA167LCW235	<p>SAT 16 x 7 T/LC 6 WHITE WHEEL c/w 235/70R16 TYRE (WHEEL CAP: 1180KG TYRE CAP: 950KG) PLY RATING: 6PLY</p>	106T	
SA167LC5235	<p>SAT 16 x 7 T/LC 5 WHITE WHEEL c/w 235/70R16 TYRE (WHEEL CAP: 1180KG TYRE CAP: 950KG) PLY RATING: 6PLY</p>	106T	

PLEASE NOTE: TYRE BRANDS ARE : LUHE, HAIDA and WANDA & LOAD RATING CAN BE SLIGHTLY HIGHER or LOWER ACCORDING to BRAND)

PART NO.	DESCRIPTION	LOAD RATING
83AMWO	8" x 3" AXLE MOUNT WHEEL (PLAIN) c/w BEARINGS	375KG
83HTWO	8" x 3" HT MAG WHEEL (PLAIN) c/w MAG WHEEL NUTS INNER/OUTER OFFSETS : 40 /56	375KG
945AMWO	9" x 4.5" AXLE MOUNT WHEEL (PLAIN) c/w BEARINGS	610KG
945HTWO	9" x 4.5" HT MAG WHEEL (PLAIN) c/w MAG WHEEL NUTS INNER/OUTER OFFSETS : 69/73	650KG
103AMWO	10" x 3" AXLE MOUNT WHEEL (PLAIN) c/w BEARINGS	550KG
1035HTMWO	10" X 3.5" HT MAG WHEEL (PLAIN) c/w MAG WHEEL NUTS INNER/OUTER OFFSETS : 50/60	550KG
1035MMWO	10" X 3.5" MINI MAG WHEEL (PLAIN) c/w MAG WHEEL NUTS INNER/OUTER OFFSETS : 50/60	550KG



PART NO.	DESCRIPTION	LOAD RATING
SA13FG	13 x 4.5 GALV. FORD WHEEL INNER/OUTER OFFSETS : 70/65	650KG
SA14FG	14 x 6 GALV. FORD WHEEL INNER/OUTER OFFSETS : 105/72	850KG
SA14FW	14 x 6 WHITE FORD WHEEL INNER/OUTER OFFSETS : 104/73	850KG
SA14HTW	14 x 6 WHITE HT WHEEL INNER/OUTER OFFSETS : 104/73	850KG
SA14HQW	14 x 6 WHITE HQ WHEEL INNER/OUTER OFFSETS : 104/73	850KG
SA14LCW	14 x 6 WHITE TLC(6) WHEEL INNER/OUTER OFFSETS : 104/73	850KG
SA15FW	15 x 6 WHITE FORD WHEEL INNER/OUTER OFFSETS : 91/91	1150KG
SA156LCW	15 x 6 WHITE TLC(6) WHEEL INNER/OUTER OFFSETS : 90/85	1150KG
SA15LCW	15 x 7 WHITE TLC(6) WHEEL INNER/OUTER OFFSETS : 94/110	1150KG
SA166LCW	16 x 6 WHITE TLC(6) WHEEL INNER/OUTER OFFSETS : 90/90	1700KG
SA167LCW	16 x 7 WHITE TLC(6) WHEEL INNER/OUTER OFFSETS : 103/103	1180KG
SA167LC5	16 x 7 WHITE TLC(5) WHEEL INNER/OUTER OFFSETS : 103/103	1180KG



SATCE



PART NO.	DESCRIPTION	LOAD RATING
83AMWO	SATCE 14 x 5.5 FORD BLACK MAG WHEEL c/w DOME & CHROME NUTS	990KG

PART NO.	DESCRIPTION	LOAD RATING
SA13165	165/70R13LT TYRE ONLY TREAD PATTERN: LRP118 SPEED RATING: 110KM/H	435KG
SA13165LT	165R13LT TYRE ONLY TREAD PATTERN: LRP118 SPEED RATING: 110KM/H	670KG
SA14185X	185/65R14 TYRE ONLY TREAD PATTERN: ENERGY X1 SPEED RATING: 110KM/H	530KG
SA14185	185R14C TYRE ONLY TREAD PATTERN: LRP138 SPEED RATING: 110KM/H	825KG
SA15195	195R15LT TYRE ONLY TREAD PATTERN: LRP138 SPEED RATING: 105KM/H	950KG
SA14195	195R14LT TYRE ONLY TREAD PATTERN: WR082 SPEED RATING: 105KM/H	925KG



LRP118



ENERGY X1



LRP138



WR082

PART NO.	DESCRIPTION	LOAD RATE
SA15225	<p>225/70R15C TYRE ONLY TREAD PATTERN:WR082 SPEED RATING: 110KM/H</p>	1120KG
SA15235	<p>235/75R15LT TYRE ONLY TREAD PATTERN:WR097 SPEED RATING: 105KM/H</p>	900KG
SA1531105	<p>31 x 10.5R15 TYRE ONLY TREAD PATTERN: HD818 SPEED RATING: 110KM/H</p>	1030KG
SA16235	<p>235/70R16 TYRE ONLY TREAD PATTERN: HD617 SPEED RATING: 110KM/H</p>	950KG



WR082



WR097



HD818



HD617

PART NO.	DESCRIPTION	LOAD RATING
50010TT	<p>500 x 10 TYRE & TUBE BRAND: DEESTONE SIZE: 5.00 - 10 RATING: 8 PLY TYPE: LIGHT TRUCK HIGHWAY TYRE PATTERN: D100</p>	500 KG
565009-J2	<p>600 x 9 TYRE & TUBE JR VALVE BRAND: KENDA SIZE: 6.9/6.00 - 9 RATING: 6 PLY TYPE: HIGHWAY TYRE PATTERN: K364</p>	590 KG
564840	<p>400 x 8 TYRE & TUBE BRAND: KENDA SIZE: 4.80/4.00 - 8 RATING: 6 PLY TYPE: HIGHWAY TYRE PATTERN: K371</p>	335 KG
571610	<p>350 x 4 TYRE & TUBE BRAND: KENDA SIZE: 4.10/3.50 - 4 RATING: 4 PLY TYPE: TURF TYRE PATTERN: K352</p>	160 KG
SA18850	<p>18 X 8.5 X 8 RIB TYRE TUBELESS NYLON BRAND: WANDA RATING: 8 PLY TYPE: RIB TYRE PATTERN: P508</p>	85 KG



D100



K364



K371



K352



P508



WINCHES

- ALKO WINCHES & PARTS
- JARRETT WINCHES & PARTS
- IMP. WINCHES & PARTS
- ROCK WINCHES



136 Port Wakefield Road, CAVAN SA 5094

Ph. 08 8262 7170 Fax. 08 8262 6123

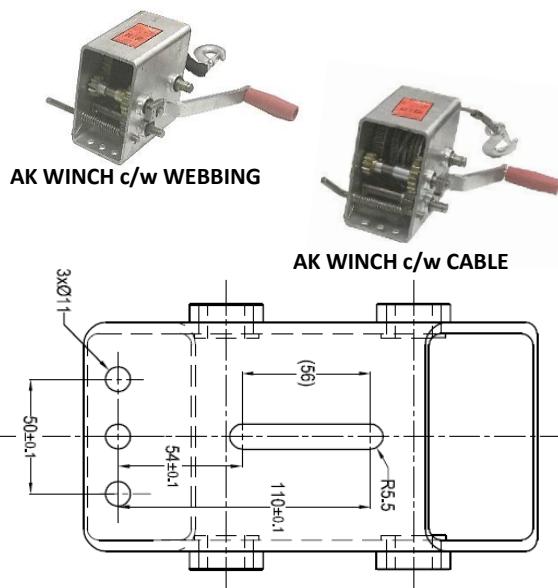

www.satrailer.com.au

AL-KO Premium Marine Winches come in 5 capacities – 250kg, 500kg, 700kg, 1000kg and 1200kg, and are available with cable or webbing. Perfectly suited for quick boat retrieval onto a multi-roller trailer all 500 kg and above AL-KO Premium Marine Winches are multi speed with 2 or 3 speeds. The 1:1 ratio enables the initial retrieval of the boat onto the rollers and the second (or third) ratios allow for the full weight of your boat to be pulled onto the trailer, with ease. These winches are of the highest quality to ensure long trouble free operation. They feature ultra high strength shaft bushes, a stainless steel drive shaft, drive pawl and spring system for maximum corrosion resistance. A unique feature of the Premium range is the galvanised rectangular frame that provides the high resistance to torsional distortion. The clever handle design allows quick release and re-attachment to the desired gear shaft without the operator having to jump from one side of the trailer to the other. The bolt hole patterns suit most existing boat trailers.



Base/ Mounting Details

PART NO.	CABLE / WEBBING	RATED LINE FULL CAPACITY	GEAR RATIO	HOOK	CABLE LENGTH	WEBBING LENGTH	HANDLE LENGTH	WEIGHT
635001W	WEBBING	250KG	1:1	"S"	--	50MM X 4M	190MM	3.4KG
635003	CABLE	500KG	3:1 1:1	"S"	4MM X 6M	--	190MM	4.1KG
635003W	WEBBING	500KG	3:1 1:1	"S"	--	50MM X 4M	190MM	3.9KG
635005	CABLE	700KG	5:1 1:1	SNAP	5MM X 6M	--	190MM	6.9KG
635005W	WEBBING	700KG	5:1 1:1	SNAP	--	50MM X 6M	190MM	6.8KG
635010	CABLE	1000KG	10:1 5:1 1:1	SNAP	6MM X 7.5M	--	190MM	8.6KG
635010W	WEBBING	1000KG	10:1 5:1 1:1	SNAP	--	50MM X 7.5M	190MM	8.1KG
635015	CABLE	1200KG	15:1 5:1 1:1	SNAP	6MM X 7.5M	--	190MM	8.7KG
635015W	WEBBING	1200KG	15:1 5:1 1:1	SNAP	--	50MM X 7.5M	190MM	8.2KG

	PART NO.	DESCRIPTION
	635905	WINCH HANDLE (STD.) 190mm
	632541	AK 11 TOOTH WINCH COG
	632542	AK 22 TOOTH WINCH COG
	632543	AK 33 TOOTH WINCH COG
	632531	AK 16mm WINCH BUSH
	632532	AK 20mm WINCH BUSH

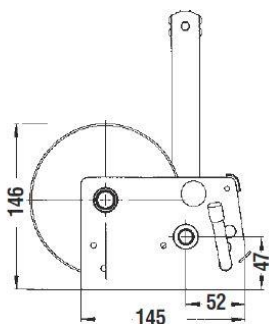

Side Elevation

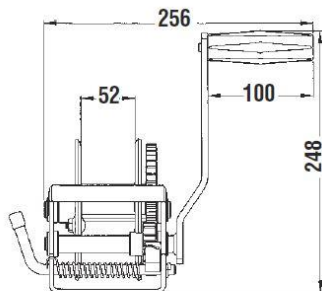

Front Elevation

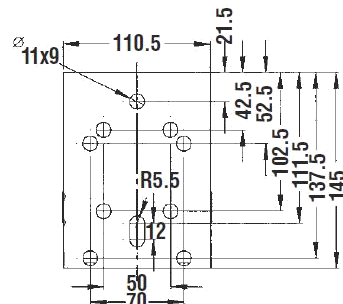

Boltdown Specs.

F10212 3:1 L/DUTY WINCH (SMALL) c/w CABLE



TYPE OF RATCHET	APPLICATION	RATED CAPACITY	CABLE BREAKING STRAIN	CABLE (AS SUPPLIED)	MAX. EFFORT ON HANDLE @ RATED LOAD
LEVER ACTION	PULLING	500KG (4900N)	865KG	6m X 4mm	20KG

F10202 3:1 L/DUTY WINCH (SMALL) c/w WEBBING



TYPE OF RATCHET	APPLICATION	RATED CAPACITY	MASS (NO WEBBING)	WEBBING (AS SUPPLIED)	MAX. EFFORT ON HANDLE @ RATED LOAD
LEVER ACTION	PULLING	500KG (4900N)	3.81KG	6m	20KG

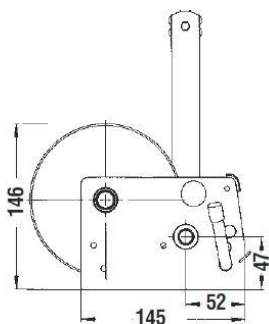

Side Elevation

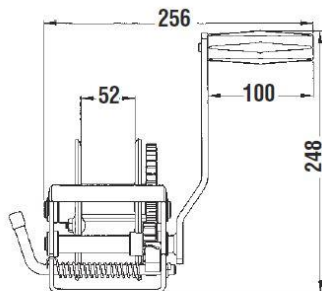

Front Elevation

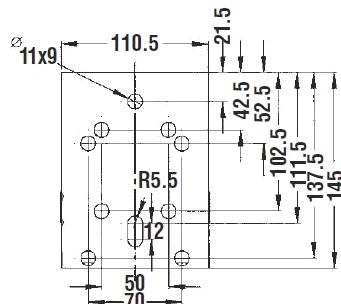

Boltdown Specs.

F10214

5:1 MED/DUTY WINCH

c/w CABLE



TYPE OF RATCHET	APPLICATION	RATED CAPACITY	CABLE BREAKING STRAIN	CABLE (AS SUPPLIED)	MAX. EFFORT ON HANDLE @ RATED LOAD
LEVER ACTION	PULLING	700KG (6860N)	865KG	6m X 4mm	25KG

F10204

5:1 MED/DUTY WINCH

c/w WEBBING



TYPE OF RATCHET	APPLICATION	RATED CAPACITY	MASS (NO WEBBING)	WEBBING (AS SUPPLIED)	MAX. EFFORT ON HANDLE @ RATED LOAD
LEVER ACTION	PULLING	700KG (6860N)	4.07KG	6m	25KG

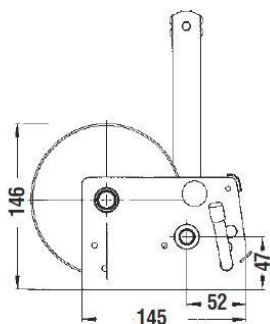

Side Elevation

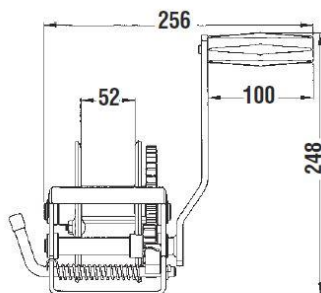

Front Elevation

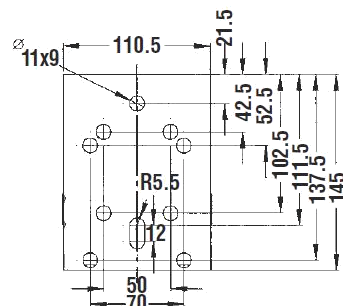

Boltdown Specs.

F10217

5:1 1:1 H/DUTY WINCH

c/w CABLE



TYPE OF RATCHET	APPLICATION	RATED CAPACITY	CABLE BREAKING STRAIN	CABLE (AS SUPPLIED)	MAX. EFFORT ON HANDLE @ RATED LOAD
LEVER ACTION	PULLING	700KG (6860N)	1855KG	6m X 5mm	25KG

F10206

5:1 1:1 H/DUTY WINCH

c/w WEBBING



TYPE OF RATCHET	APPLICATION	RATED CAPACITY	MASS (NO WEBBING)	WEBBING (AS SUPPLIED)	MAX. EFFORT ON HANDLE @ RATED LOAD
LEVER ACTION	PULLING	700KG (6860N)	4.07KG	6m	25KG

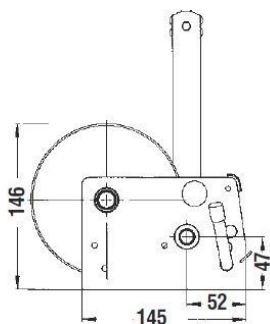

Side Elevation

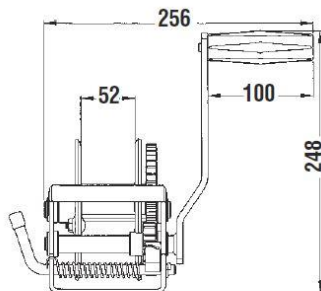

Front Elevation

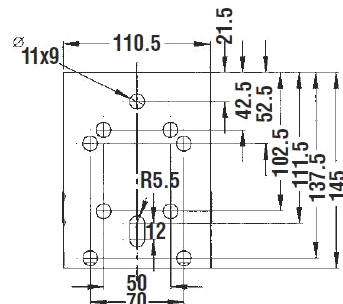

Boltdown Specs.

F10950 10:1 5:1 1:1 EX. H/DUTY WINCH c/w CABLE

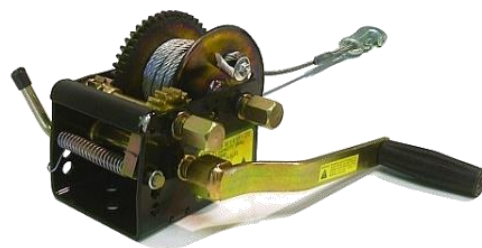

TYPE OF RATCHET	APPLICATION	RATED CAPACITY	CABLE BREAKING STRAIN	CABLE (AS SUPPLIED)	MAX. EFFORT ON HANDLE @ RATED LOAD
LEVER ACTION	PULLING	800KG – 1000KG	1855KG	7.5m X 5mm	18KG

F10952 10:1 5:1 1:1 EX. H/DUTY WINCH c/w WEBBING



TYPE OF RATCHET	APPLICATION	RATED CAPACITY	MASS (NO WEBBING)	WEBBING (AS SUPPLIED)	MAX. EFFORT ON HANDLE @ RATED LOAD
LEVER ACTION	PULLING	800KG – 1000KG	4.99KG	7.5m	18KG

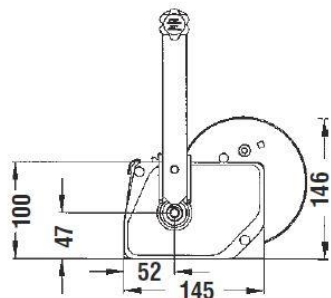

Side Elevation

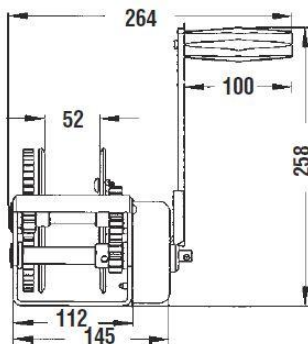

Front Elevation

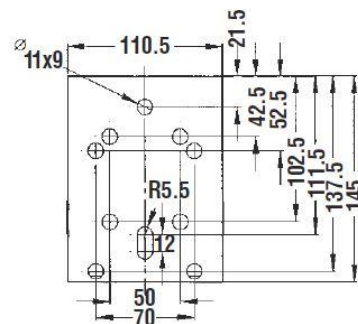

Boltdown Specs.

F18230

5:1 (300KG) BRAKE WINCH c/w CABLE

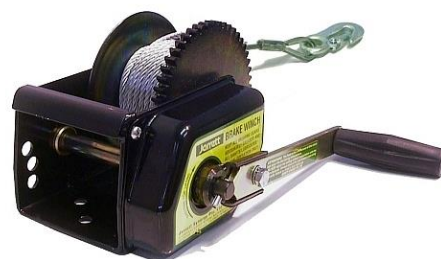

TYPE OF BRAKE	APPLICATION	RATED CAPACITY	CABLE BREAKING STRAIN	CABLE (AS SUPPLIED)	MAX. EFFORT ON HANDLE @ RATED LOAD
SELF ACTUATING	LIFTING	300KG (2940N)	1905KG	7.5m X 5mm	26KG

F18260

10:1 (500KG) BRAKE WINCH c/w CABLE



TYPE OF BRAKE	APPLICATION	RATED CAPACITY	CABLE BREAKING STRAIN	CABLE (AS SUPPLIED)	MAX. EFFORT ON HANDLE @ RATED LOAD
SELF ACTUATING	LIFTING	500KG (4900N)	2800KG	7.5m X 6mm	18KG



Part No.	Description
51D	4mm x 6mtr. Cable c/w Snap Hook
51E	5mm x 6mtr. Cable c/w Snap Hook
10111G	6mm x 5.5mtr. Cable c/w Snap Hook



Part No.	Description
51F	6mtr. Webbing c/w Snap Hook
10111H	7.5mtr. Webbing c/w Snap Hook

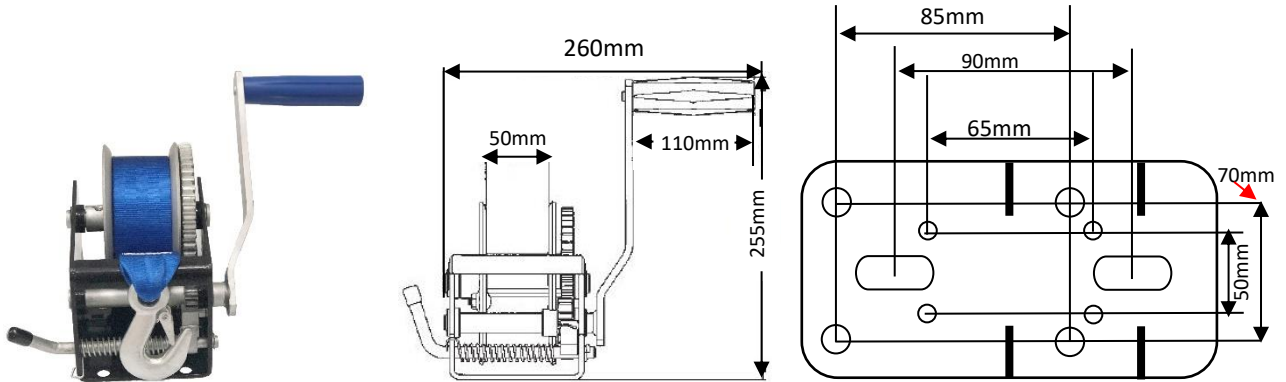

3:1 BLACK POWDER COATED WINCH c/w 7mtr BLUE WEBBING

PART NO.	RATED CAPACITY	WEBBING SIZE	WEIGHT
SAHW31W	500KG	50mm x 7mtr	5.1KG



3:1 BLACK POWDER COATED WINCH c/w 6mtr BLUE ROPE

PART NO.	RATED CAPACITY	ROPE SIZE	WEIGHT
SAHW31R	500KG	4mm x 6mtr	5.1KG

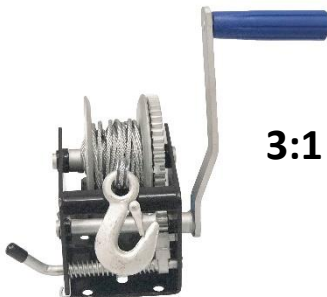

3:1 BLACK POWDER COATED WINCH c/w 6mtr CABLE

PART NO.	RATED CAPACITY	CABLE SIZE	WEIGHT
SAHW31C	500KG	4mm x 6mtr	5.1KG

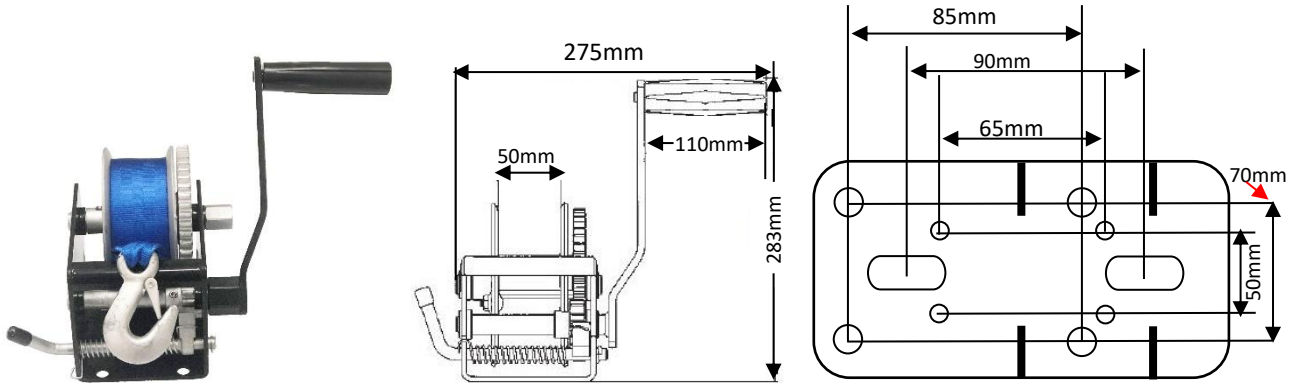

5:1 1:1 BLACK POWDER COATED WINCH c/w 7mtr BLUE WEBBING

PART NO.	RATED CAPACITY	WEBBING SIZE	WEIGHT
SAHW51W	700KG	50mm x 7mtr	5.2KG

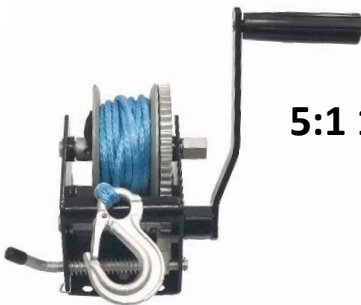

5:1 1:1 BLACK POWDER COATED WINCH c/w 7.5mtr BLUE ROPE

PART NO.	RATED CAPACITY	ROPE SIZE	WEIGHT
SAHW51R	700KG	5mm x 7.5mtr	5.2KG

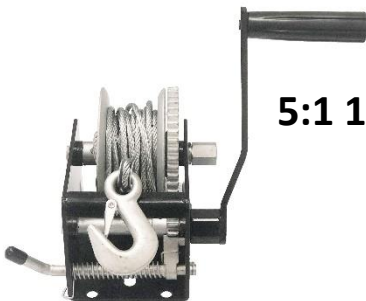

5:1 1:1 BLACK POWDER COATED WINCH c/w 7.5mtr CABLE

PART NO.	RATED CAPACITY	CABLE SIZE	WEIGHT
SAHW51C	700KG	5mm x 7.5mtr	5.2KG

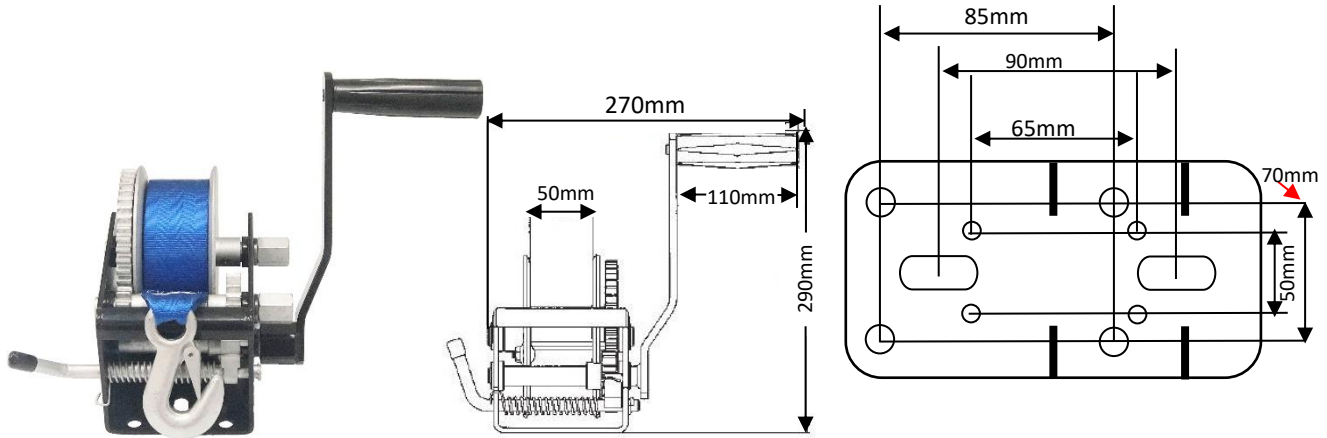

**10:1 5:1 1:1 BLACK POWDER COATED
WINCH c/w 8mtr BLUE WEBBING**

PART NO.	RATED CAPACITY	WEBBING SIZE	WEIGHT
SAHW101W	1000KG	50mm x 8mtr	5.7KG

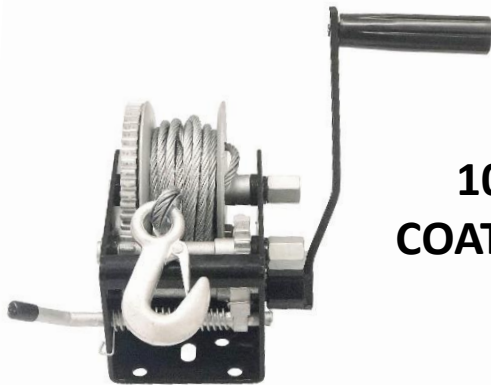

**10:1 5:1 1:1 BLACK POWDER
COATED WINCH c/w 7.5mtr CABLE**

PART NO.	RATED CAPACITY	CABLE SIZE	WEIGHT
SAHW101C	1000KG	5mm x 7.5mtr	5.7KG

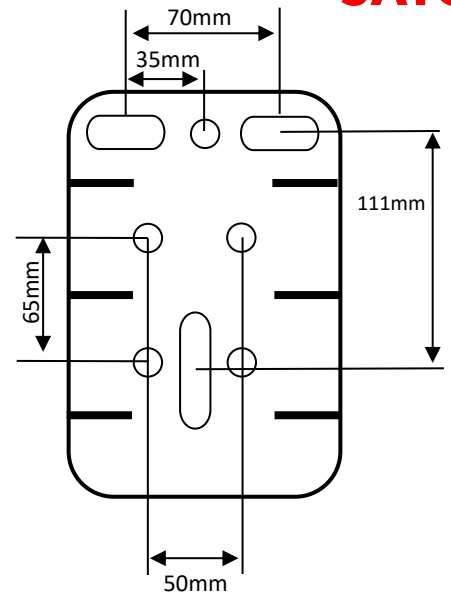
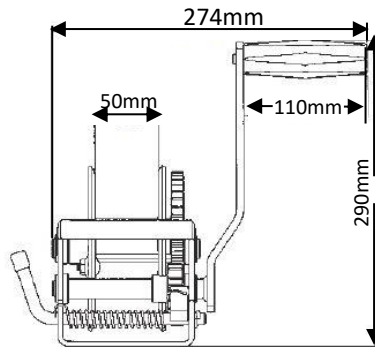
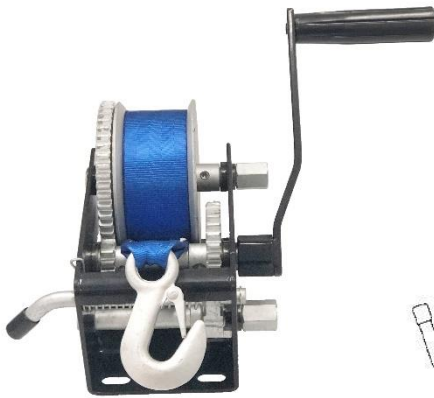

**15:1 4.5:1 1:1 BLACK POWDER COATED
WINCH c/w 8mtr BLUE WEBBING**

PART NO.	RATED CAPACITY	WEBBING SIZE	WEIGHT
SAHW151W	1500KG	50mm x 8mtr	6.7KG

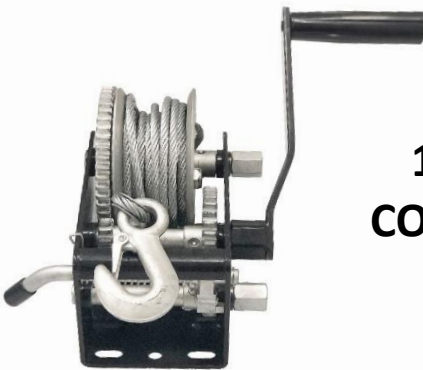

**15:1 4.5:1 1:1 BLACK POWDER
COATED WINCH c/w 7.5mtr CABLE**

PART NO.	RATED CAPACITY	CABLE SIZE	WEIGHT
SAHW151C	1500KG	5mm x 7.5mtr	6.7KG

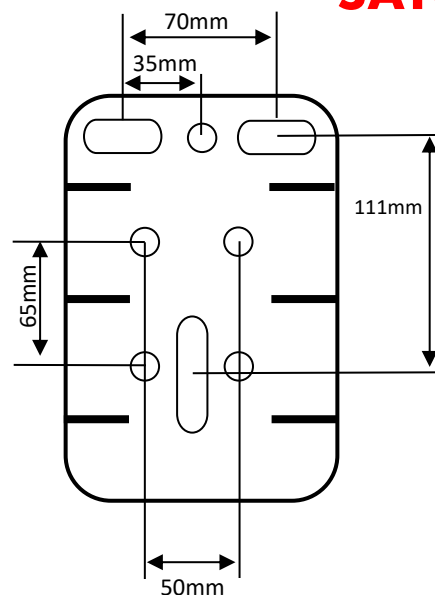
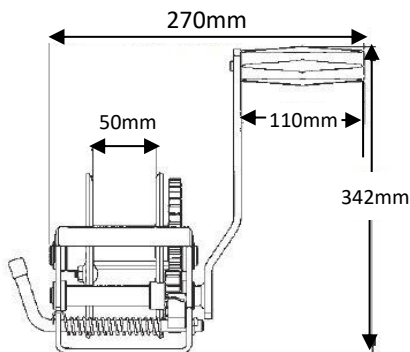
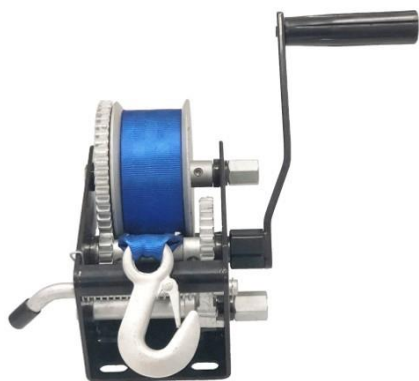

17:1 5:1 1:1 BLACK POWDER COATED WINCH c/w 10mtr BLUE WEBBING

PART NO.	RATED CAPACITY	WEBBING SIZE	WEIGHT
SAHW171W	2000KG	50mm x 10mtr	6.7KG



17:1 5:1 1:1 BLACK POWDER COATED WINCH c/w 10mtr CABLE

PART NO.	RATED CAPACITY	CABLE SIZE	WEIGHT
SAHW171C	2000KG	5mm x 10mtr	6.7KG

	PART NO.	DESCRIPTION
	SA507W	SPARE BLUE WEBBING c/w SNAP HOOK (50mm x 7mtrs)
	SA508W	SPARE BLUE WEBBING c/w SNAP HOOK (50mm x 8mtrs)
	SA5010W	SPARE BLUE WEBBING c/w SNAP HOOK (50mm x 10mtrs)
	SA46C	SPARE CABLE c/w SNAP HOOK (4mm x 6mtrs)
	SA57C	SPARE CABLE c/w SNAP HOOK (5mm x 7.5mtrs)
	SA67C	SPARE CABLE c/w SNAP HOOK (6mm x 7.5mtrs)
	SA610C	SPARE CABLE c/w SNAP HOOK (6mm x 10mtrs)
	SA46R	SPARE BLUE ROPE (4mm x 6mtrs)
	SA57R	SPARE BLUE ROPE (5mm x 7.5mtrs)
	SAWHB	SPARE POWDER COATED HANDLE (230mm) (BL PACK)
	SAWHD	SPARE POWDER COATED HANDLE (230mm) (BL PACK)



SAEW1500

SATCE 12V ELECTRIC BOAT TRAILER WINCH c/w 5.5MM ROPE & REMOTE - 1500KG

POWER / MANUAL IN & OUT, WITH REMOTE CONTROL & HANDLE NO THERMAL SAFETY OVERLOAD

CAPACITY	WIRE ROPE	ELECTRICAL CABLE	SWITCH CABLE	METAL GEAR TRAIN	MOTOR (HP)	DRUM SPEED	DRUM SIZE	GROSS WEIGHT
1570KG	5.5MM x 10.5MTRS	3MTRS	3MTRS	453 :1	300W	1.38 METER PER MINUTE	75MM DIA x 82MM LENGTH	13 / 12.5KG



SAEW900

SATCE 12V ELECTRIC BOAT TRAILER WINCH c/w 4.8MM ROPE & REMOTE - 900KG

POWER / MANUAL IN & OUT, WITH REMOTE CONTROL & HANDLE NO THERMAL SAFETY OVERLOAD

CAPACITY	WIRE ROPE	ELECTRICAL CABLE	SWITCH CABLE	METAL GEAR TRAIN	MOTOR (HP)	DRUM SPEED	DRUM SIZE	GROSS WEIGHT
907KG	4.8MM x 9.2MTRS	3MTRS	3MTRS	464 :1	280W	1.38 METER PER MINUTE	75MM DIA x 82MM LENGTH	11.5 / 11KG

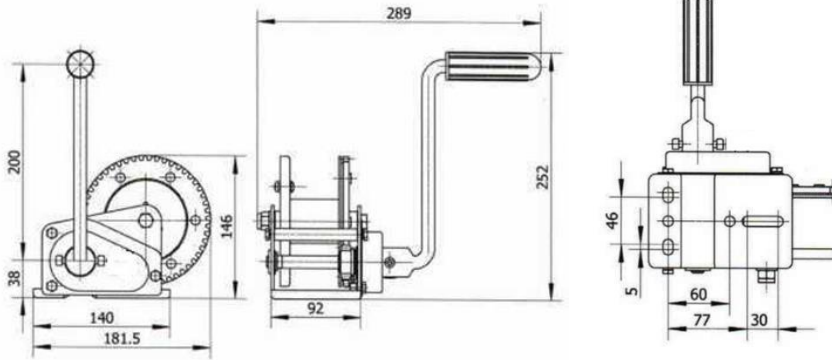

AL01572

RBW1500 BRAKE WINCH c/w CABLE

CAPACITY	GEAR RATIO	CABLE/SYNTHETIC ROPE (mm x m)	STRAP (mm x mm x m)	GROSS WEIGHT (kgs)
1500 lb (681 Kg)	5.1:1	Φ4.76 x 17	1.2 x 40 x 8	3.5

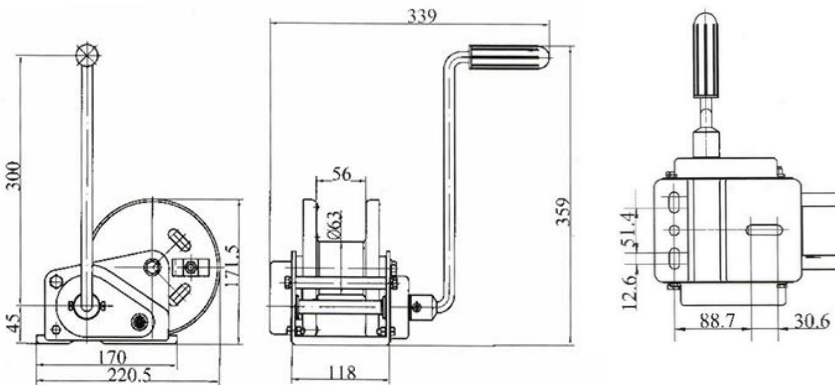

AL01576

RBW2500 BRAKE WINCH c/w CABLE

CAPACITY	GEAR RATIO	CABLE/SYNTHETIC ROPE (mm x m)	STRAP (mm x mm x m)	GROSS WEIGHT (kgs)
2500 lb (1135 Kg)	11.1:1	Φ6.35 x 17	1.4 x 60 x 10	6.3



136 Port Wakefield Road, CAVAN SA 5094

Ph. 08 8262 7170 Fax. 08 8262 6123

www.satrailer.com.au